

thinklogical[®]

A **BELDEN** BRAND

SMP3

System Management Portfolio 3.0

PRODUCT MANUAL

Revision D, July 2024

SMP Software
SMP ADM
SMP Dashboard
SMP Appliance
SMP Module
SMP Client

Table of Contents

PREFACE	6
About Thinklogical A BELDEN BRAND	6
About this Product Manual	7
Active Links.....	7
Note and Warning Symbols	7
Class 1 Laser Information	7
Scope	7
INTRODUCTION	8
The SMP i7 Appliance	8
Connections.....	8
LEDs.....	9
Hardware Configuration	9
The SMP i7 Client	10
Connections.....	10
LEDs.....	10
Connecting SMP Clients to the System.....	11
OSD Pooling	11
<i>TECH NOTES: OSD is not coming up correctly</i>	13
SMP i7 Appliance & Client i7 Technical Specifications.....	14
The SMP Module	15
Connections.....	15
LEDs.....	15
Navigating the SMP Module and SMP Client Front Panel LCD	16
The SMP Appliance	17
The SMP Appliance	17
The Front Panel	17
Navigating the SMP Appliance Front Panel LCD.....	17
THE REAR PANEL	18
Connections.....	18
SMP Appliance Technical Specifications	19
The SMP Client	20
Connections.....	20
LEDs.....	20
Connecting SMP Clients to the System.....	20
Cable Connection Diagram	21
THE SYSTEM MANAGEMENT PORTFOLIO 3.0	22
The SMP3 Software Package	22
Login To Linux (optional).....	23
Login To SMP3 as an Administrator.....	23
Using SMP3	25
<i>TECH NOTES: Initial setup of your SMP3</i>	25
<input type="checkbox"/> The LOGOUT Tab	26
<input type="checkbox"/> The ABOUT Tab	27
<input type="checkbox"/> The ADMIN (Administration) Tab	29
<input type="checkbox"/> The SRCS (Sources) Tab.....	30

- The DSTS (Destinations) Tab 36
- The KBDS (Keyboards) Tab 36
- The FRMS (Frames) Tab 37
- TECH NOTES: Alternate Frame location** 38
 - The MTX (Matrix Switch) Tab 39
 - The HOT KEYS Tab 40
- TECH NOTES: Hotkey via mouse – “MsSwitch Toggle”** 43
 - The RESTART Tab 44
 - The TIE LINES Tab 44
 - The USERS Tab 46
 - The TAGS Tab 51
 - AUTOZOOM and EZ view 52
 - The POOLS Tab 55
- TECH NOTES: Unexpected POOLS on the OSD** 58
- The MACROS Tab 59
- The OVERLAY Tab 66
- The COMBI Tab 68
- The CONNECT Tab 69
- The DRAG (Drag & Drop) Tab 72
 - Using POOLS 74
 - TECH NOTES: Customize Drag & Drop** 78
 - Sample Images 79
 - TECH NOTES: Adj. the appearance of Touchpanel Drag & Drop** 79
- The SHARE button 79
- The Refresh Button 80
- Configuration Backup 81
- The SMP ADM** **82**
- Introduction** **82**
- ADM Features** **82**
- Setup** **83**
- Connection Diagram** **83**
- Using ADM** **84**
 - Logging in 84
 - The NETWORK Tab 85
 - The HOSTNAME Tab 85
 - The ETH0 Tab 85
 - The ETH1 Tab 86
 - The MACSEC Tab 86
 - The REDUNDANCY Tab 88
 - The PING Tab 89
 - The GUIDE Tab 90
 - The SECURITY Tab 92
 - The PASSWORDS Tab 92
 - The HTTPS Tab 93
 - The CERT Tab 93
 - The FIPS Tab 94
 - The FIREWALL Tab 95
 - The BANNER Tab 96
 - The USERS Tab 97
 - The LINUX Tab 97
 - The ADM Tab 98
 - The SMP Tab 98
 - The DATE / TIME Tab 99

□ The SYSLOG Tab.....	100
□ The AUDIT LOGGING Tab.....	100
□ The REMOTE OPTIONS Tab.....	101
□ The LOGS Tab	102
□ The DOWNLOAD SELECTED Tab	103
□ The DISPLAY LIVE Tab	104
□ The SERVICES Tab	105
□ The ABOUT Tab	106
□ The LOGOUT Tab	106
DASHBOARD	107
□ The MONITOR Tab	107
The MONITOR Tab's TX and RX Columns	107
□ The Transmitter (TX) Tab	109
□ The Receiver (RX) Tab.....	109
□ The MTX (Matrix Switch) Tab.....	110
□ The FIRMWARE Tab.....	111
□ The SETTINGS Tab.....	112
□ The ABOUT Tab	113
□ The LOGOUT Tab	113
Regulatory Compliance.....	114
Symbols Found on Our Products	114
Regulatory Compliance.....	114
Standards with Which Our Products Comply.....	114
Supplementary Information	115
Product Serial Number.....	115
Connection to the Product.....	115
Thinklogical Support.....	116
Customer Support	116
Technical Support	116
Product Support	116
Appendix A: Ordering / Configuration Guide	117
Appendix B: SSL Certificates for HTTPS	118
Appendix C: Key SMP3 File Locations (Accessible by root user only)	118
Appendix D: Enable Hot Keys (Out Of Band)	119
Appendix E: Flex Keys	121
<i>TECH NOTES: Programming many Receiver Modules.....</i>	<i>127</i>
Appendix F: SMP3 Redundancy	128
Appendix G: Protocols and Port Numbers	132
Appendix H: Intuitive Mouse Setup.....	133
Appendix I: “Persistent” Feature.....	134
Appendix J: SMP3 API (v.19).....	136
Appendix K: Backing up the configuration	151
Appendix L: Upgrading from prior versions.....	152

Copyright Notice

Copyright © 2024. All rights reserved. Printed in the U.S.A.

All trademarks and service marks are the property of their respective owners.

Initial release date, November 2021, Revision A.

Subject: System Management Portfolio 3.0 Product Manual

Revision: D, July 2024



thinklogical

A **BELDEN** BRAND



MADE IN USA



Website: <https://www.thinklogical.com>

Facebook: www.facebook.com/ThinklogicalUSA

LinkedIn: www.linkedin.com/company/thinklogical

YouTube: www.youtube.com/user/thinklogicalNA

Twitter: [@thinklogical](https://twitter.com/thinklogical)

PREFACE

About Thinklogical A BELDEN BRAND

Thinklogical, a Belden Brand, is the leading manufacturer and provider of fiber-optic video, KVM, audio, and peripheral extension and switching solutions used in video-rich, big-data computing environments.

Thinklogical is headquartered in Milford, Connecticut and is owned by Belden, Inc., St. Louis, MO (<http://www.belden.com>). For more information about Thinklogical products and services, please visit <https://www.thinklogical.com>.



Certified to
ISO 9001:2015



About this Product Manual

Active Links

This document contains active cross-reference links in the *Table of Contents* and for referenced pages throughout, shown in this format: [17], and active hyperlinks, shown in this format: [link.format](#). For .pdf, *point/click*, for .doc: *Ctrl/point/click*. To **return to the front of the document** press *Ctrl/Home*.

Note and Warning Symbols

Throughout this manual you will notice certain symbols that bring your attention to vital information. These are **Notes** and **Warnings**. Examples are shown below.



Note: A note is meant to call the reader's attention to helpful or valuable information at a point in the text that is relevant to the subject under discussion.



Warning! A warning is meant to call the reader's attention to critical information at a point in the text that is relevant to the subject under discussion.

Class 1 Laser Information

Thinklogical® products are designed and identified as **Class 1 LASER products**. This means the maximum permissible exposure (MPE) cannot be exceeded when viewing the laser with the naked eye or with the aid of typical magnifying optics, such as a magnifying glass or eye loupe.

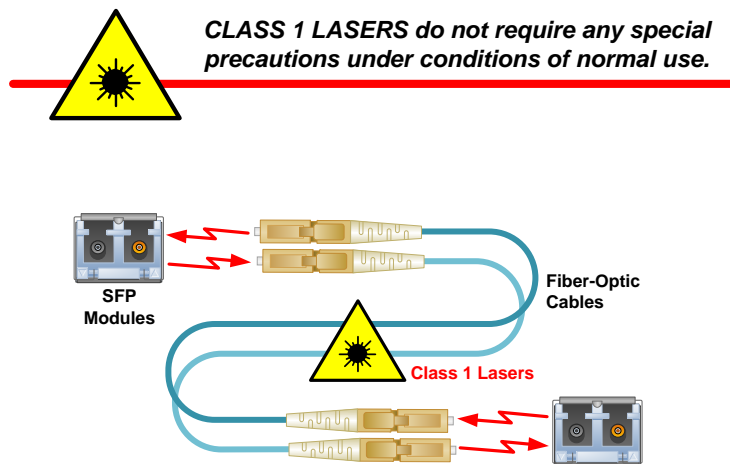

Scope

This document describes the functionality of **Thinklogical's® System Management Portfolio 3.0**, also known as *SMP3*, a managed configuration and control system for Thinklogical's VX, MX and TLX line of Matrix Switches. (See *note, below*.)

Note: SMP3 does NOT support the VX160 or VX320 Matrix Switches due to hardware restrictions.

INTRODUCTION

The **Thinklogical® System Management Portfolio 3.0**, or SMP3, control system is available on three hardware platforms, onto which is installed a Linux operating system and the System Management Portfolio software suite. There is also an SMP Client Module, available on two hardware platforms that is used for OSD functionality.

SMP3 is available in 6G (VX) and 10G (TLX), Multi-mode and Single-mode and i7 varieties (SMP i7 and OSD i7).

The SMP i7 Appliance

The SMP i7 Appliance is a quarter-width form-factor product that installs in one of the slots in a **Thinklogical® CHSHP4** chassis.

For chassis information see: [Manual_Integrated_Client_Transmitter_Rev_G.pdf](#).



SMP-i7-Appliance, rear panel

Connections

- **CONSOLE** – Serial console to the Linux operating system. Datacom parameters are: 38,400 baud, 8 bit, 1 stop, no parity.
- **USB** – USB 2.0 connections for keyboard and mouse.
- **HALT** – Halt button for resetting the unit.
- **VIDEO OUT** – Video connection to the Linux desktop.
- **VID/HID** – Fiber connection to the Linux desktop.
- **RX MON** – Connection to the Matrix Switch for monitoring (see Dashboard section).
- **TX MON** – Connection to the Matrix Switch for monitoring.
- **NETWORK** – Ethernet connection to the system which can include: Matrix Switches, Touchpanels, OSDs, etc.
- **UPDATE** – Serial USB connection. Used for firmware updates and also configuring the fiber optic transmitter portion of the SMP-i7-Appliance.

LEDs

SFP	T LED	R LED	Condition
VID/HID, RX/TX MON	Blinking GRN	Blinking GRN	Normal
VID/HID, RX/TX MON		Blinking RED	Cannot lock onto data
VID/HID, RX/TX MON		Off	No signal (back channel)
NETWORK	GRN	GRN	Link up – 1Gbs
NETWORK	GRN	Off	Link up – 100Mbs
NETWORK	Off	GRN	Link up – 10Mbs
NETWORK	Off	Off	Link Down
NETWORK	RED	RED	SFP fault

Hardware Configuration

IP address – The default IP address is 192.168.13.9. If the IP address needs to be changed it is done with the **ADM** utility.

- Connect a keyboard, monitor, and mouse and power up the unit.
- A browser page will display in full screen kiosk mode; hit F11 to toggle kiosk mode.
- Choose the second browser tab which is <https://localhost:60087> to open the SMP ADM application.
- Enter **admin** for *username* and **admin** for *password*.
- The IP Config page will appear. Enter the desired IP address and click on SET ETH0.
- Reboot the SMP (Applications Menu/Logout/Restart).

Video Parameters – The default video resolution is 1920x1080p and is normally left unchanged. However, if it does need to be modified:

- Connect a USB cable from the UPDATE port to a PC.
- Open a terminal emulation program such as PuTTY.
- Choose; Serial, the COM port to use, 38,400 baud, 8 bit, 1 stop, no parity.
- Hit <return> and you should see the main menu.

```

COM5 - PuTTY
----- Integrated Client TX Main Menu -----
1: System Information                6: SFP Parameters
c: Set Video Resolution              d: Show Current Resolutions
e: Ethernet SFP Parameters          f: Set Local Control Name
g: Mouse Screen Select              h: Server Auto Log out
  
```

- Choose “c: Set Video Resolution” for the next menu.

```

COM5 - PuTTY
----- Integrated Client TX Load EDID Tables Menu -----
0: 1920 x 1080 P60 EDID HDMI        1: 1920 x 1200 P60 EDID HDMI
2: 2560 x 1440 P60 EDID HDMI        3: 3840 x 2160 P30 EDID HDMI
4: 1920 x 1080 P60 EDID eDP         5: 1920 x 1200 P60 EDID eDP
6: 2560 x 1440 P60 EDID eDP         7: 3840 x 2160 P30 EDID eDP
8: 1920 x 1080 P60 EDID PRI DVI     9: 1920 x 1080 P60 EDID eDP DVI
  
```

- Choose 0-3 to set the resolution of the HDMI port (the eDP port is not present in these units).

The SMP i7 Client

The SMP i7 Client is a quarter-width form-factor product that installs in one of the slots in a **Thinklogical**® CHSHP4 chassis. It provides a dedicated browser to the SMP3 that is customized to the assets of the Desk and User.

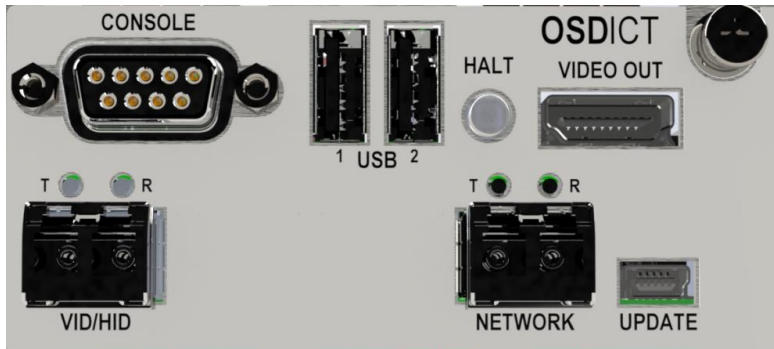

Client-i7, rear panel

Connections

- CONSOLE – Serial console to the Linux operating system. Datacom parameters are: 38,400 baud, 8 bit, 1 stop, no parity.
- USB – USB 2.0 connections for keyboard and mouse.
- HALT – Halt button for resetting the unit.
- VIDEO OUT – Video connection to the OSD.
- VID/HID – Fiber connection to the OSD.
- NETWORK – Ethernet connection to the system which can include Matrix Switches, Touchpanels, OSDs, etc.
- UPDATE – Serial USB connection. Used for firmware updates and also configuring the fiber optic transmitter portion of the SMP i7 Client.

LEDs

SFP	T LED	R LED	Condition
VID/HID	Blinking GRN	Blinking GRN	Normal
VID/HID		Blinking RED	Cannot lock onto data
VID/HID		Off	No signal (back channel)
NETWORK	GRN	GRN	Link up – 1Gbs
NETWORK	GRN	Off	Link up – 100Mbs
NETWORK	Off	GRN	Link up – 10Mbs
NETWORK	Off	Off	Link Down
NETWORK	RED	RED	SFP fault

Connecting SMP Clients to the System

In larger deployments it may be desirable to have multiple SMP Clients in a system to allow several users to access the system simultaneously. This is known as an "OSD Pool" in that if an OSD is in use, the system will deliver the next available OSD at a user's request. OSD Pooling requires configuring each SMP Client Module separately.

 **Note:** OSD Pooling is handled automatically by the system. Do not create a Pool for OSDs in the POOLS tab.

 **Note:** When powered up the SMP Client may display an "Unable to connect" page. If so, wait a few minutes and click on the [Try Again] button.

OSD Pooling

1. Add the SMP Clients to the *Sources* tab in the SMP configuration as **OSD1**, **OSD2**, **OSD3**, etc., the spelling is important.
2. Configure each SMP Client with a unique IP address using ADM:
 - Connect a keyboard, monitor, and mouse and power up the unit.
 - After booting, a browser page will display. Enter F11 to exit kiosk mode.
 - Open a new browser tab with <https://localhost:60087> to open the SMP Client ADM application.
 - Enter **admin** for *username* and **admin** for *password*.

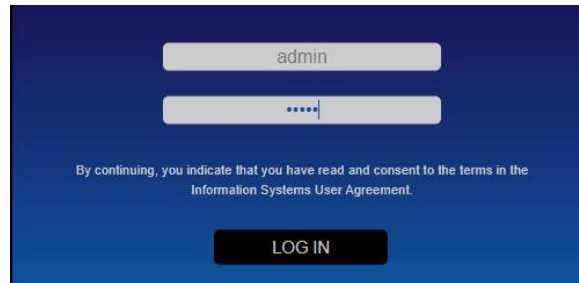

- Navigate to the SMP tab at the bottom, then enter the correct IP address of the SMP the SMP Client needs to connect to.

 **Note:** For convenience, it is best to do this first, prior to changing the IP address.



- Navigate to the NETWORK tab at the bottom, then the ETH0 tab at the top. Enter the correct IP address for the SMP Client, then hit [SET ETH0]. The change will take place immediately

and the application will restart. If needed, you will need to browse to ADM at the new IP address.

HOSTNAME	ETH0	PING	GUIDE
ETH0	<input type="radio"/> DHCP		
IP ADDRESS	192.168.13.111		
IP MASK	255.255.255.0		
GATEWAY			
MAC	00:0c:83:00:eb:5f		

SET ETH0

NETWORK SECURITY USERS DATE / TIME SMP SYSLOG LOGS SERVICES ABOUT LOGOUT admin

 **Warning!** Avoid IP addresses that are already in use. For example, the default addresses for a matrix switch are **192.168.13.15**, **192.168.13.115** and **192.168.13.16**. The default address for the SMP Module or SMP Appliance is **192.168.13.9**.

 **Note:** The SMP3 Client URL is different than the URL used for SMP2. This needs to be changed if upgrading to SMP3 from SMP2.

 **Note:** For SMP3 Clients without ADM, see prior version of the SMP3 manual on our website.

SMP Client Kiosk Mode

 **Note:** The SMP Client **must** run its browser in Kiosk Mode to be accessible to the system.

 **Note:** OPTIONAL - To disable the F11 key (kiosk mode toggle), edit the .xinitrc file by removing the # from this line:

```
#bin/xmodmap -display :0 -e "keycode 95 = "
```

Then reboot the device. (This is because F11 is code 95 in Linux.)

Default OSD Page

When the SMP3 Client Module powers up, it will automatically boot up and be ready for use. The initial browser page will be as shown below (if observed on a monitor connected directly). When the OSD is called by a Keyboard User at a Desk, the SMP3 will automatically populate the page with the appropriate assets for that Desk / Keyboard User. These assets are Sources, Destinations, Tags and Pools available to that Keyboard User. Assets can also include which pages are available to use; Drag & Drop, Connect or COMBI. See also the USERS section in this manual.

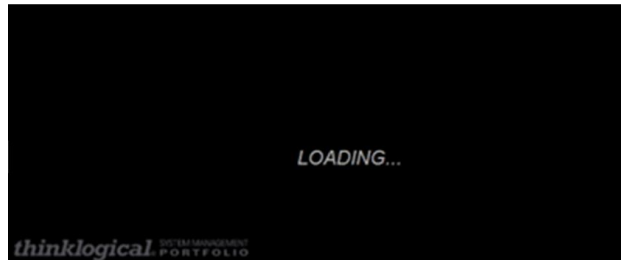

TECH NOTES: *OSD's not coming up correctly*

There may be situations where the OSDs are not responsive, but the rest of the System is behaving normally. This may be caused by: unexpected power downs, SMP3 Appliance/Module reset, or network issues. The solution is to reset or refresh the OSDs one by one.

1. Route the OSD to a Destination (or connect a monitor, keyboard & mouse directly).
2. Press F5 to refresh the browser.
3. Call the OSD with a Hotkey. If that doesn't work then:
4. Hit ctrl+alt+F1 to get to the Linux prompt and login as root.
5. Type "reboot" to reboot the OSD.
6. When finished the OSD will display "LOADING..." meaning it is ready for use.



Note: After calling an OSD, the User may easily revert to the Source that was previously there by hitting the <esc> key.



Note: A SOURCE must be a member of at least one TAG to be usable by the OSD.



Warning! To operate correctly, OSDs need to be called by a Hotkey. Connecting OSDs manually, for example via Drag & Drop, should only be done for maintenance purposes.

SMP i7 Appliance & Client i7 Technical Specifications

PHYSICAL	
Chassis CHS-HP0004	Rack Size: EIA 19"
	Width: 17.47" (443.8 mm)
	Height (1 RU): 1.72" (43.7 mm)
	Depth: 14.00" (355.6 mm)
	Weight (Chassis only): 9.0 lbs. (4.08 kg)
	Shipping Weight: 11 lbs. (4.99 kg)
	Weight (Chassis & 4 Modules): 13.8 lbs. (6.26 kg)
	Shipping Weight: 15 lbs. (6.80 kg)
Chassis Status LEDs	Module Temp (1-4), Module Status (1-4), Chassis Fans, Chassis Alarm, Power Supplies 1-2
I7 Unit	Weight (1 module): 1.2 lbs. (.54 kg)
	Shipping Weight: 2 lbs. (.91 kg)
Interfaces	1 Serial Console, 2 USB-A, 1 HDMI Video Out, 2 or 3 fiber SFPs, 1 RJ-45 or fiber Network SFP, 1 USB-mini-B Update
Chassis Cooling	Six fans per chassis: 12VDC, 40x40mm 10.8CFM (306 L/min.)
Module Cooling	Four fans per module: 5VDC, 20x20mm 1.3CFM (.036m ³ /min.)
ENVIRONMENTAL	
Temperature	Operating: 0° to 50°C (32°F to 122°F) Ambient Storage: -20°C to 70°C (-4°F to 158°F)
Humidity	Operating: 5% to 95%, non-condensing Storage: Unlimited
Altitude	Operating: Thinklogical components are rated to 1000m max. elevation. Max. operating temp. derates by 3% for every 330m > 1000m Storage: Unlimited
ELECTRICAL	
Input Rating	100-240VAC, 1.5A, 50-60Hz (for CHSHP4 chassis)
Max. Power Consumption	50W per module
THERMAL	Heat load 170 BTU/HR
RELIABILITY	MTBF (calculated): 46.7K hrs.
WARRANTY	1 Year from date of shipment. Extended warranties available.

The SMP Module

The SMP Module is a “Q Module” form factor product that installs in one of the slots in a **Thinklogical®** CHS2 or CHS4 chassis.

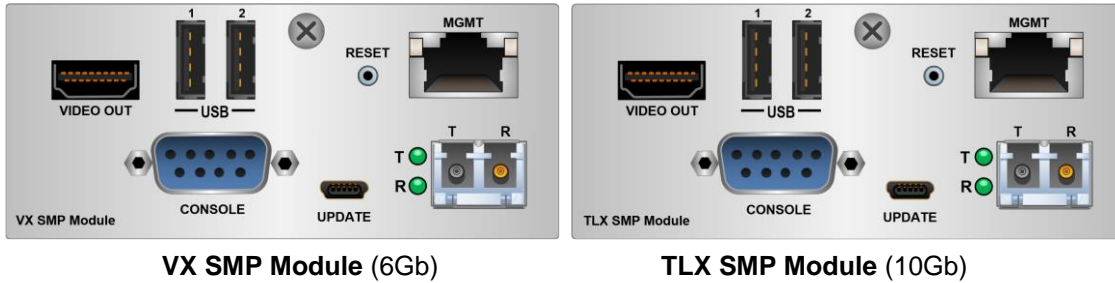

Connections

- VIDEO OUT, USB – These provide a direct connection for a monitor, keyboard, and mouse to the Linux desktop. It also supports USB flash drives if a small hub is added (not included).
- CONSOLE – This is a serial console connection to the Linux desktop. Datacomm parameters are: 115,200 baud, 8 bits, No parity, 1 stop bit.
- RESET – Hardware reset button.
- MGMT – Ethernet port used for connection to the Matrix Switch(es), SMP Client(s) and Touchpanels.
- UPDATE – Used for updating the FPGA firmware.
- SFP – Used for a fiber optic TX connection to the Linux desktop. *Used for initial set-up and installation. Thinklogical recommends NOT connecting the SFP to the Matrix Switch during normal operation.*

LEDs

RJ-45 connector LEDs indicate the mode of operation (**1G orange**, **100M green**, or **10M yellow**) with blinking as an indication of activity.

Fiber Status	Top LED	Bottom LED	Condition
T Active – Video OK	Green	-----	T active and transmitting data
R Active – Data OK	-----	Green	R active and transmitting data
R Active – No Data	-----	Red	R active, no data from Receiver

Navigating the SMP Module and SMP Client Front Panel LCD

Main Menu

SMP_MCO6

#Network Parameters

- Static IP Address IP = 000.000.000.000
- Static Subnet Mask Subnet = 255.255.255.000
- Static Gateway Address GW = 000.000.000.000
- DHCP Mode DHCP = DISABLED

#System Parameters

- Card Type Type = 0xFD
- FPGA Rev. Rev = 0001.00.04
- Software Rev. Rev = 6
- Serial Number S/N = 10-190212
- FPGA Temp. in C 39
- Board temp. in C 38
- Low Speed connected No
- Local Ctrl Name Name = OSD-01
- Remote Ctrl. Name Name = Not Found
- Load Factory Defaults Yes/No = No

#SFP1 Parameters

- SFP1 Vendor Mfg = FINISAR CORP
- SFP1 Part Number P/N = FTLF8528P3BNV
- SFP1 Wavelength WL = 850
- SFP1 TX Power TX Power = 0.467mW
- SFP1 RX Power RX Power = 0.002mW
- SFP1 TX Bias Bias = 7.318uA

#Alarms

- SFP1 Loss Of Signal On
- Chassis Error Off
- System Reboot Off
- Configuration Changed Off
- Remote Heartbeat Lost On
- High Temperature Alarm Off
- Clear Alarms No

The SMP Appliance

The SMP Appliance is a 19" rack-mount unit with the same SMP3 software as the SMP i7 and SMP Module, but also features two Ethernet hubs and monitoring connections to the Matrix Switch. The SMP Appliance also supports Overlay.

The Front Panel



SMP Appliance, front panel

- Dual redundant, hot-swappable, load-sharing 120W power supplies, located on the front panel.
- RESET – Hardware reset button.
- UPDATE - USB-mini B connector for FPGA firmware updates.
- LCD and navigation buttons for device configuration and download.

Navigating the SMP Appliance Front Panel LCD

Main Menu – The date and time is read from the Linux kernel. Change the date and time via the Linux command line.

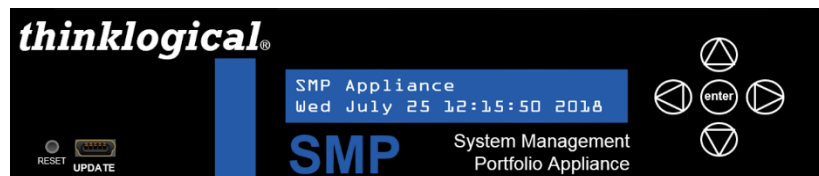

Reboot/Poweroff – Use this function prior to unit power-down. This may also be done from a terminal session on the SMP3.

Program Network – Allows the Ethernet address parameters of Eth0 to be changed at the front panel. This may also be done from the SMP3 ADM browser page.

View Network - Allows viewing of the Ethernet address parameters of Eth0. This is useful if the IP address of Eth0 is unknown (changed from the default).

View System – Allows various system parameters to be viewed, including:

- **smp-appl-release** – The version of Linux machine appliance software that the SMP runs on.
- **FPGA** – The release of the FPGA software where **2.x.xx** is for 6Gb units and **3.x.xx** is for 10 Gb units.
- **Serial Number** – Serial number of the SMP3 Appliance.
- **SFP LOS** – SFP loss of signal where "1" indicates the loss of signal (see SFP table below).
- **SFP DES OK** – Indicates a valid connection to a destination such as a receiver or switch where "1" is a valid connection.
- **PS1 IN OK PS2 IN OK** – Shows the power supply status where PS1 is near the power cord and PS2 is near the LCD panel. **IN** = "1" means the power supply is installed and **OK** = "1" shows it is operating and supplying power.
- **Fan Alarm** – The status of the four internal fans where "1" is an alarm condition.
- **Temperature** – Where **imx** is the processor temperature and **FPGA** is the FPGA chip temperature.
- **Exit to Main Menu** – Hit [enter] to return to the home menu level.

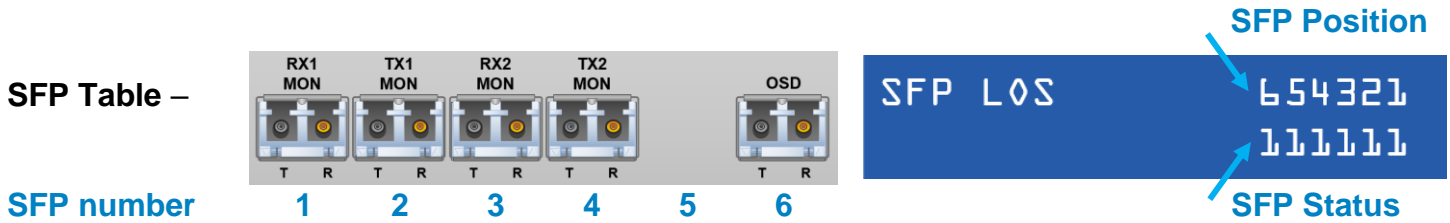

Note: These ports must be configured in the SMP3 to enable them. See DASHBOARD section.

THE REAR PANEL

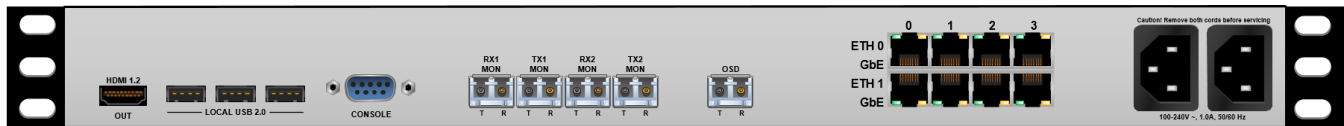

SMP Appliance back panel

Connections

- HDMI 1.2 OUT, LOCAL USB 2.0 – These provide a direct connection for a monitor, keyboard, and mouse to the Linux desktop. It also supports USB flash drives.
- CONSOLE – This is a serial console connection to the Linux desktop. Datacom parameters are: 115,200 baud, 8 bits, No parity, 1 stop bit.
- RX1 MON, TX1 MON, RX2 MON, TX2 MON – These provide fiber optic connections to a Matrix Switch for the Monitoring function. Also used for the Overlay feature.
- OSD – Used for a fiber optic TX connection to the Linux desktop. *Used for initial set-up and installation. Thinklogical recommends NOT connecting the OSD port to the Matrix Switch during normal operation.*
- ETH0 – A 4-port unmanaged ethernet hub typically used for connection to a site’s enterprise network.
- ETH1 – A 4-port unmanaged ethernet hub typically used for connection to a site’s Matrix Switch(es), SMP Client(s) and Touchpanels (private network).
- AC Power – Connections for dual, redundant, hot swappable power supplies.

RJ-45 connector LEDs indicate the mode of operation (**1G orange**, **100M green**, or **10M yellow**) with blinking as an indication of activity.

SMP Appliance Technical Specifications

PHYSICAL	
Rack-Mountable Chassis Dimensions	Rack Size: EIA 1 in 1U Depth: 14.0 in (355mm) Width: 17.5 in (445 mm) Weight: 9.5 lbs. (4.3 kg) Shipping Weight: 18 lbs. (8.2 kg)
I/O Ports	Front Panel: 1 USB-mini <i>Firmware Updates</i> Rear Panel: 1 HDMI-A <i>Local Monitor</i> 3 USB-A <i>Local Keyboard/Mouse/Firmware</i> 1 DB-9F RS-232 <i>Console Port</i> 5 Duplex LC SFP <i>Fiber connections to/from Matrix Switch</i> 8 RJ45 <i>10/100/1000 BaseT 802.11 Ethernet</i> 2 IEC 60320-C14 <i>AC Power Inlet</i>
ENVIRONMENTAL	
Temperature	Operating: 0° to 50°C (32°F to 122°F) Ambient Storage: -20°C to 70°C (-4°F to 158°F)
Humidity	Operating: 5% to 95%, non-condensing Storage: Unlimited
Altitude	Operating: Thinklogical components are rated to 1000m max. elevation. Max. operating temp. de-rates by 3% for every 330m > 1000m Storage: Unlimited
ELECTRICAL	
Input Rating	100-240VAC, 0.33A, 50-60Hz
Power Consumption	35W (0.33A @ 115VAC)
THERMAL	
	Heat load 120 BTU/HR
WARRANTY	
	One year from date of shipment. Extended warranties available.

The SMP Client

The SMP Client is a “Q Module” form-factor product that installs in one of the slots in a **Thinklogical®** chassis. It provides user-customized *OSD (On Screen Display)* functionality to the user’s configuration.

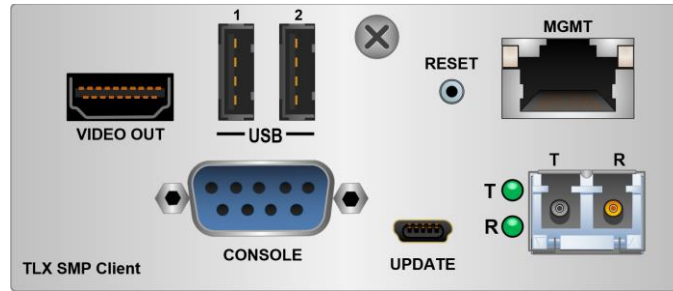

Connections

- VIDEO OUT, USB – These provide a direct connection for a monitor, keyboard, and mouse to the Linux desktop. It also supports USB flash drives.
- CONSOLE – This is a serial console connection to the Linux desktop. Datacom parameters are: 115,200 baud, 8 bits, No parity, 1 stop bit.
- RESET – Hardware reset button.
- MGMT – Ethernet port used for connection to the Matrix Switch(es), SMP Client(s) and Touchpanels.
- UPDATE – Used for updating the FPGA firmware.
- SFP – Used for a fiber optic TX connection to the Matrix Switch.

LEDs

RJ-45 connector LEDs indicate the mode of operation (**1G orange, 100M green, or 10M yellow**) with blinking as an indication of activity.

Fiber Status	Top LED	Bottom LED	Condition
T Active – Video OK	Green	-----	T active and transmitting data
R Active – Data OK	-----	Green	R active and transmitting data
R Active – No Data	-----	Red	R active, no data from Receiver

Connecting SMP Clients to the System

See “Connecting SMP Clients to the System” above. The procedure is the same as the SMP i7 Client.

Cable Connection Diagram

Depicted below is a simple, but typical system with one Source and one Destination shown here (for clarity) as well as an SMP Client (OSD) and a Touchpanel.

In this example, the “SMP3 Client 1” shown may be an SMP3 Client Module or a Client i7 module. The “SMP3 Appliance” shown may be an SMP3 Appliance, an SMP3 Module or an SMP i7 Appliance.

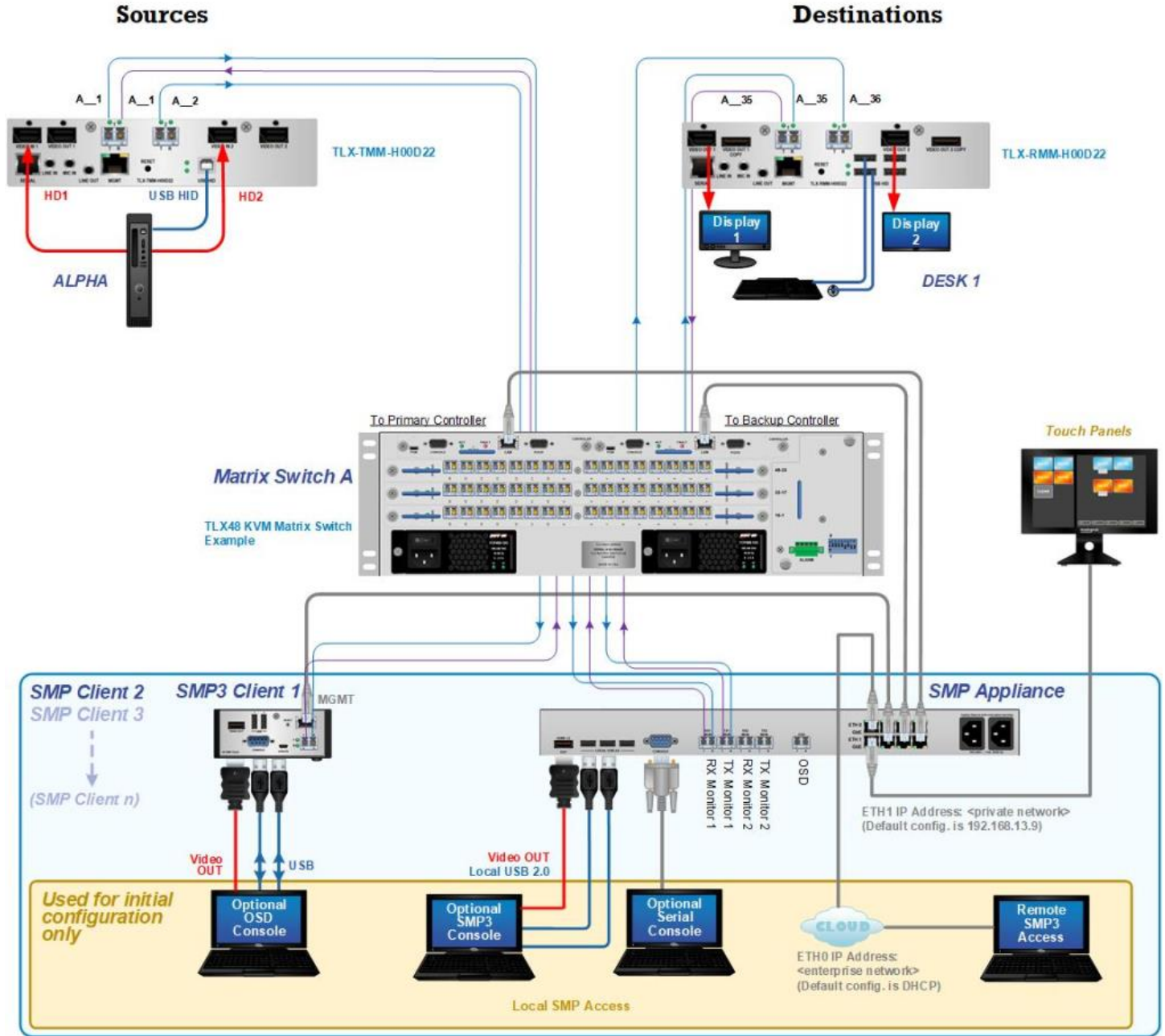

Warning! Some systems may include more than one SMP3 unit (Appliance or module). While this is an acceptable design, care must be taken when configuring them. **ONLY ONE** unit should have Hotkeys configured and **ONLY ONE** unit can have Tie Lines configured. This does not apply to SMP units set up as Redundant. See: SMP Redundancy.

THE SYSTEM MANAGEMENT PORTFOLIO 3.0

The SMP3 Software Package

Thinklogical's *System Management Portfolio 3.0* is a specialized software package that provides powerful remote management and maintenance capabilities, making it easier for users to configure, operate and update Thinklogical signal extension and switching systems of any size.

Among the key enhancements of SMP3:

- Hierarchical Drag & Drop, with zoom feature
- OSD Drag & Drop, Connect and Combi pages available.
- Advanced Pooling
- SMP3 API (Application Programming Interface)
- Touchpanel Drag & Drop, Connect and Combi pages available.



Note: SMP3 supports the POE Touchpanels TPL-00007 and TPL-00010. Discontinued Touchpanel models VXM-000011 and VXM-000016 are not supported.

The intuitive graphical user interface enables fast set-up and control of each Matrix Switch in the system. Tabs along the bottom of the screen allow users to navigate through the various configuration and usage pages.



The **Drag & Drop** Graphical User Interface makes it easy for users to visualize their workstations on-screen and switch Sources and Destinations by simply moving an icon. As room configurations evolve over time, icons representing Sources and Destinations can be added or removed from the layout as required, making it simple to adapt to changing requirements.

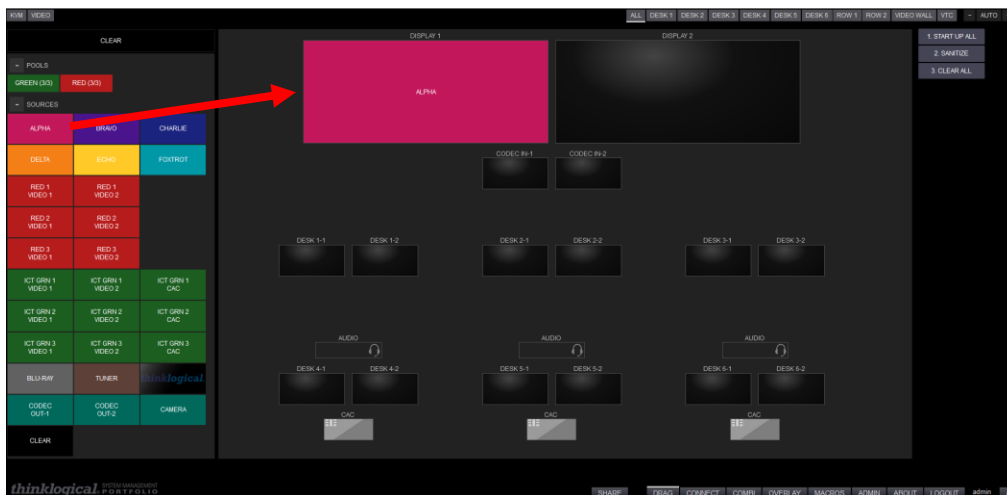

A sample configuration is graphically depicted above in the Drag & Drop GUI, with Sources on the left, Destinations In the center, and Macros on the right. Connections can be made or changed simply by clicking on an icon and dragging it to a desired location. Macros can be executed with a single click.

Login To Linux (optional)

For security and performance reasons, when powering up or rebooting an SMP3 Appliance, Module or Client it will finish with the browser open in kiosk mode. There will not be a Linux desktop.

- To change to the Linux terminal prompt: Hit <ctrl+alt+F1>
- To change to the browser: Hit <ctrl+alt+F7>
- To toggle kiosk mode: Hit F11.

At the terminal prompt default credentials are: user/user. You may then elevate to root if required.

Default password is: root

(Remote login as root is not enabled.)

If you need to change these credentials use the Linux `passwd` command or use the ADM interface.

Login To SMP3 as an Administrator

The System Management Portfolio 3.0 is accessed via a web browser from any computer on the same network as the SMP3 server (or direct connection). The SMP3's port number is :**60090**. Set the browser's URL to your IP address, for example: <https://192.168.13.9:60090>, to load the page. When directly connected to the SMP3 Appliance or SMP3 Module you may use: <https://localhost:60090>.

Logins are required to access these pages and the following will be displayed:

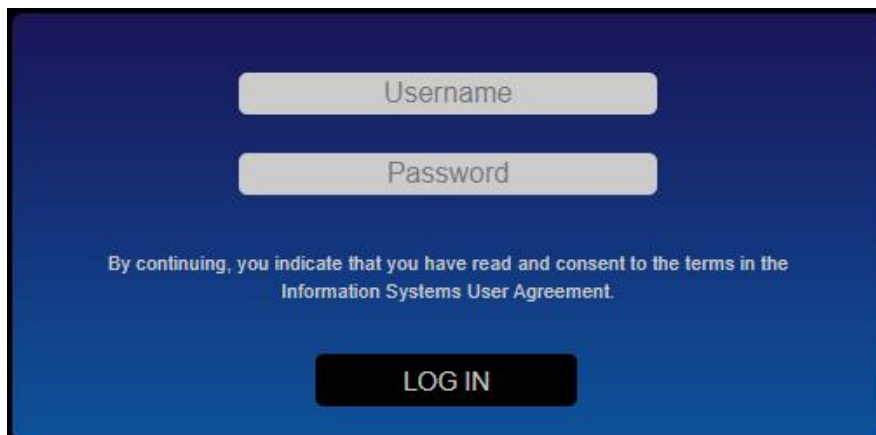

The administrator's default Username and Password are:
admin / admin

(This can be changed by the administrator.)

Additional SMP3 Users can be created with different assets available to them, see ADM section.



Warning! The SMP3 Appliance, SMP3 Module and SMP3 Client modules are Linux® based devices and should not be powered off without a controlled shut-down. Prior to powering down, issue a SHUTDOWN function from ADM / LOGOFF or a *poweroff* command from a terminal window. On an SMP Appliance you may also use the front panel for this purpose.

ADM LOGOUT options:

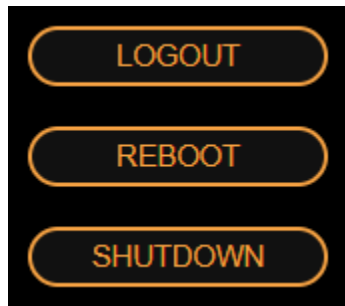

Using SMP3

In the following scenarios we will use a typical, but not overly complicated, Thinklogical deployment with one Matrix Switch, 20 Sources (including an SMP Client module OSD1) and 10 Destinations as shown below. *This is the configuration represented by most of the screenshots that follow.*

Sources:

ALPHA
BRAVO
CHARLIE
DELTA
ECHO
FOXTROT
RED 1
RED 2
RED 3
ICT GRN 1
ICT GRN 2
ICT GRN 3
BLU-RAY
TUNER
LOGO
CODEC OUT-1
CODEC OUT-2
CAMERA
OSD1
SMP

Destinations:

DESK 1
DESK 2
DESK 3
DESK 4
DESK 5
DESK 6
DISPLAY 1
DISPLAY 2
CODEC IN-1
CODEC IN-2

Pools:

CODEC
GREEN
RED

Macros:

1. START UP ALL
2. SANITIZE
3. CLEAR ALL

TECH NOTES: *Initial setup of your SMP3*

If you are creating your SMP3 configuration yourself, Thinklogical recommends that you "start small," especially if your system has dozens, or even hundreds, of Sources and Destinations.

- You may wish to connect just a few of your Sources and Destinations to first get a feel for how connections are made and broken and how to name and group Sources, Destinations and Matrix Switches.
- As you become more familiar with the system, you can add more extenders, connect multiple Matrices with Tie-Lines and create Macros to help you better manage and maintain deployments of any size.

When SMP3 opens with administration rights, there will be this selection of tabs along the bottom of the page. The login name (in this case 'admin' is visible at the extreme right). Clicking these tabs takes the administrator to the pages used to set-up and manage SMP3.

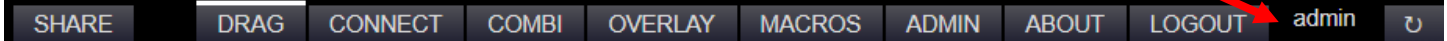

□ The LOGOUT Tab

The LOGOUT tab will present two options:

- LOGOUT will take the user out of the current session and open a new Login window, where the user can begin a new session under a different log-in.
- CLEAN SCREEN will provide a 15 second opportunity to clean a Touchpanel screen.

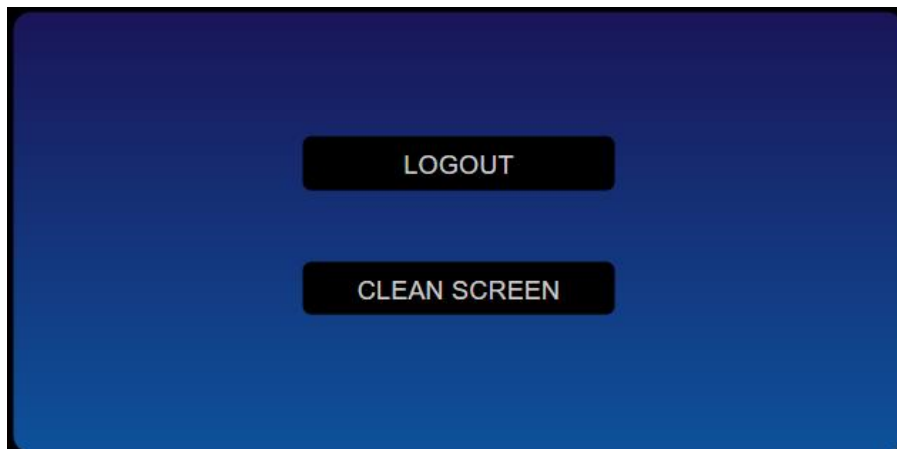

□ The ABOUT Tab

When clicked from any window, the ABOUT tab displays the installed version of SMP3 and Service Pack at the bottom of the page.

For example:

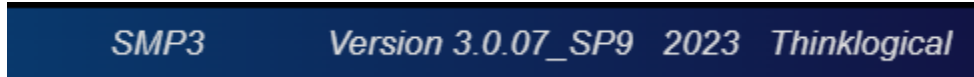

Additional ABOUT information is displayed in the ADMIN tab, with HOTKEYS selected (below).

SMP3 Version 3.0.07_SP3 2023 Thinklogical

Code Defaults	Key Combo	CTRL + CTRL	SHIFT + SHIFT	ALT + ALT	SCROLL (twice)	OSD Idle Time Out	Logout (mins)
	Code	11	22	44	55		15

Origin	Code	Action
*	11	OSD, 1
*	22	MACRO, 1, START UP, ALL, ...
*	44	MACRO, 3, CLEAR, ...
*	55	SHARE CYCLE, 1, ...
*	81	CONTROL MON, 1
*	82	CONTROL MON, 2
*	83	CONTROL MON, 3

Origin: The name of the KBD or DST that will send the code.

Code: The hex value sent by the KBD or DST that will trigger the action.

The Action that will be performed when Code is sent by KBD/DST

- OSD** When used in conjunction with one or more OSD modules, this action allows on-screen-display for connections and disconnections.
- COLLABORATE** This allows multiple users to view and control the displayed source from their own monitors.
- CAST** Copy whichever SRC is currently on the first DST to all following DSTS.
- DISABLE** Do not perform any action at this KBD/DST for this Code. This is used to defeat default actions.
- MACRO** Execute the macro(s) in the argument list.
- CONNECT** Connect the first argument (SRC) to all following arguments (DSTS).
- CONTROL** Control one (or more) SRCS. The first argument (DST) is connected to all remaining arguments (SRCS).
- MIRROR** Copy (and continue to copy) whichever SRC is sent to the first listed DST to all following DSTS.
- UNMIRROR** Stop mirroring

□ The ADMIN (Administration) Tab

The ADMIN tab is only available to an administrator logged in as *admin* and is used to configure the SMP3 workstation environment. Most other users will not see this tab. There are eleven tabs along the top left of the ADMIN page, each with a separate function. There are also four buttons on the top right. Each function is discussed below.



Warning! Source names, Destination names and KBDS names must be unique and must not match. Certain names are reserved for system functions and should not be used for site-specific Source and Destination names. These include: CLEAR, RX MON1, RX MON2, TX MON1, TX MON2, Src Name, Dst Name, or any other column header name.

Special characters should be avoided, but space, dash, period and single-underscore are allowed.

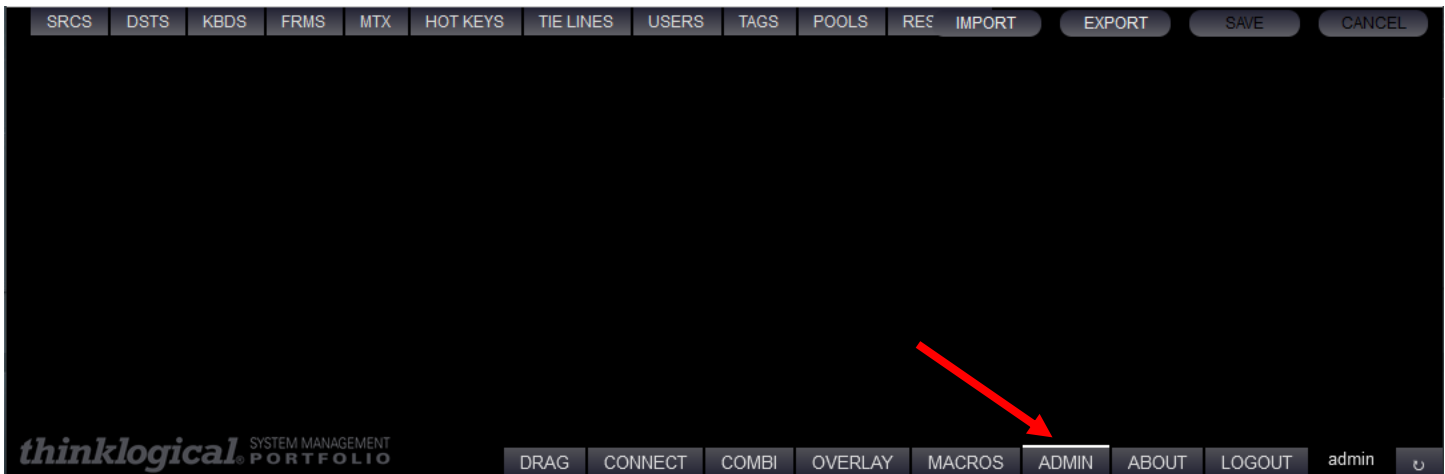

Src Name	Follows
ALPHA	
BRAVO	
CHARLIE	
DELTA	
ECHO	
FOXTROT	
RED 1-1	
RED 1-2	RED 1-1



Note: An alternate method of switching two video Sources simultaneously would be to use the two Vid(R) columns. However, using the Follows feature allows the switching of only one of the two video Sources independently if necessary. This is because each video Source has its own line defined here.

The Primary Column

The Primary column is used to indicate ‘monitor 1’ of a Pooled Source. This is utilized to support multi-asset pooling (multi-video-head, separate audio, separate USB, etc.). This is not needed for single asset Pooled Sources.



Note: This column is included in the default SMP3 configuration. However, if upgrading from SMP2 then this column needs to be added. Otherwise, Pools cannot be created.

The Port Columns

The next columns define the port mapping which consists of the Switch name and Port Number, indicating the Fiber-optic cable connection points on each Switch. Note that the “R” and “T” designations are from the Matrix Switch point of view. For example, VidA(R) is an input and Kbd(T) is an output of the Matrix Switch.

The naming convention for connections is *Switch Name-underscore-underscore-Port Number*, as in *A__1*, for example. The *double underscore* is a separator between the Switch name and the Port Number. *Double underscore is not allowed for anything but port numbers.*

On **ALPHA** for example, *A__1* indicates Port 1 is used as a Source on Switch A. This carries video *Vid(R)* and data *Kbs(R)* and *Aud(R)* from the Source to the Destination. On the same SFP, a return fiber *Kbd(T)* carries data from the Destination back to the Source. Port *A__2* is also used by Source ALPHA for either a second video head, or as the second fiber in a 4K60Hz Source.

Src Name	Follows	Primary	VidA(R)	VidB(R)	Kbd(T)	Kbs(R)	Aud(R)	!PIVd(T)	!PIVs(R)
ALPHA			A__1	A__2	A__1	A__1	A__1		

In this example port A__1 is used for both the first video and the keyboard/mouse/audio connections. However, in some systems it may be required to use different extenders for video and keyboard/mouse/audio. Different ports can be configured here for that purpose.

The Vid(R) Column

The video connection from the transmitter.

The Vid2(R) Column

This column is used for one of two purposes:

1. The second video head of a Source. The advantage is that both heads will always be routed to a Destination at the same time with one User operation. The disadvantage is that only one of them cannot be routed individually.
2. The second (required) fiber connection for a 4K60 Source.

The Kbd(T) and Kbs(R) Columns

The Kbd (keyboard data) and Kbs (keyboard status) columns are used for keyboard, mouse and tablet data. Typically this data is multiplexed on the first SFP of an extender (as illustrated above). However, these columns can accommodate extenders that have separate SFPs for HID.

The Aud(R) Column

Typically this audio data is multiplexed on the first SFP of an extender (as illustrated above). However, these columns can accommodate extenders that have separate SFPs for HID.

The EDID Column

This column is for a return channel to a video transmitter if needed for Dynamic EDID.

The !PIV Columns

The next two columns are known as “persistent” and are described in Appendix I. These are used primarily for CAC and PKI card readers.

The *Alias* Column

If left empty, the name displayed will be the same as what is entered in the **SRC Name** column. However, Aliases may be used for more user-friendly labeling of Sources and Destinations. The Alias can also be positioned in the Drag & Drop icon with the following parameters:

(l) = Left justified

(r) = Right justified

(c) = Centered

 = line break

(blank) = There will not be a name displayed and the icon cannot be “dragged.”

The *BGround* Column

The background color, or image, used by the Drag & Drop and COMBI icons. HTML color codes may be used, or an image of your choice. See Tech Note: Customizing Drag & Drop.

The *Color* Column

The text color used by the Drag & Drop and COMBI icons. HTML color codes may be used.

The *X,Y* Columns

Not used in the Sources tab. Icons are arranged automatically in order of the Rank column.

The *W,H* Columns

The icon size (percentage of Frame).

The *Level* Column

The optional Level column is commonly used for security levels 1 through 4. However, any number of Levels may be defined. This is used to define classification levels if desired with Level 1 being highest, (most restricted access). It will apply to which Sources and Destinations can be connected, depending on their Level.

For example:

- | | |
|---|--------------|
| 1 | Top Secret |
| 2 | Secret |
| 3 | Classified |
| 4 | Unclassified |

A Destination with Level 1 clearance will have access to Source Levels 1 and lower (2, 3, 4, etc). A Destination with Level 2 clearance will have access to Source Levels 2 and lower, but not Level 1, etc.



Note: When using the Level feature, keep in mind that no entry (empty) in the Level field means that Levels do not apply to that line. This would be equivalent to Level 1, or no restriction.

TECH NOTES: *Adjusting the appearance of Sources icons*

When adding Sources, icon *size* is determined by the W and H columns. However, *location* is defined by its order in the Rank column. Because the icons may not line up conveniently, a spacer (or phantom icon) can be inserted to move the next Source down one location. This will create a gap, allowing the icons following it to line up evenly. See example below:

Src Name	Follows	Primary	VidA(R)	VidB(R)	Kbd(T)	Kbs(R)	Aud(R)	!USBd(T)	!USBs(R)	Alias	BGround	Color	X	Y	W	H	Level	Rank
ALPHA-1			A_1		A_1	A_1	A_1				#C2185B	#fff			30	15		20
ALPHA-2	ALPHA-1		A_2								#C2185B	#fff			30	15		40
ALPHA-spacer										(blank)	#222	#fff			30	15		60

Example:

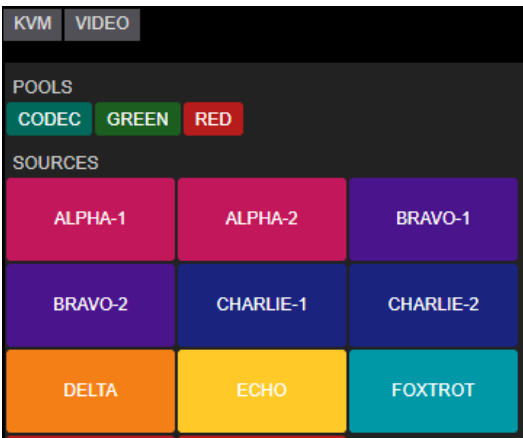

Without spacer (Bravo-1 starts after Alpha-2.)

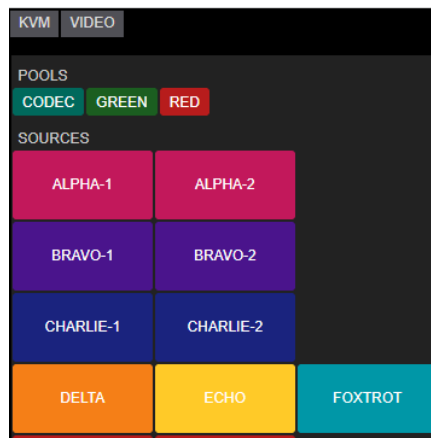

With spacer (Bravo-1 in line with Bravo-2, etc.)



Note: In the example above the spacer color is defined as #222 which is the same color as the default SRCS frame (dark gray). Optionally you may define the BGround as **transparent** which will allow the spacer to not be visible if you change the frame color.

RED 2-spacer		RED 2-1								(blank)	transparent							32	15	240
--------------	--	---------	--	--	--	--	--	--	--	---------	-------------	--	--	--	--	--	--	----	----	-----



□ The DSTS (Destinations) Tab

This tab defines Destinations such as; User desks, video walls, projectors, VTC CODECS, etc. Note that the DSTS Tab lists all Destinations including TX MON1 in the first column. TX MON should not be an icon and therefore should not have X, Y, W, H entries.

Keyboard ports are not configured in the **DSTS** Tab, use the **KBDS** Tab below. The Kbs(R) and Kbs(T) columns are only used by the Monitor feature.)

The Control column shows which destination has control of the keyboard. The names in this column must match those in the **KBDS** tab.

SRCS	DSTS	KBDS	FRMS	MTX	HOT KEYS	TIE LINES	USERS	TAGS	POOLS	RESTART							
<i>Dst Name</i>	<i>Follows</i>	<i>Vid(T)</i>	<i>Vid2(T)</i>	<i>Aud(T)</i>	<i>EDID(R)</i>	<i>IPIVd(R)</i>	<i>IPIVs(T)</i>	<i>Alias</i>	<i>BGround</i>	<i>Color</i>	<i>X</i>	<i>Y</i>	<i>W</i>	<i>H</i>	<i>Control</i>	<i>Level</i>	<i>Rank</i>
DESK 1-1		A_35	A_36								5	45	8	6	DESK 1-kbd	20	
DESK 1-2	DESK 1-1	A_37	A_38								14	45	8	6	DESK 1-kbd	40	
DESK 2-1		A_39	A_40								30	45	8	6	DESK 2-kbd	60	



Note: In the example above: EDID refers to the return channel to the transmitter and PIV stands for Personal Identification Device. This includes USB devices such as CAC and PKI cards but it can support any USB 2.0 device.

□ The KBDS (Keyboards) Tab

This tab defines where an active keyboard/mouse is located.

Follows = N/A

Kbd(R) = data from keyboard/mouse to PC (Rx to Tx), fiber L2 or K2 (data backchannels)

Kbs(T) = status from PC to keyboard/mouse (Tx to Rx), fiber L1 (video/data) or K1 (USB HID data)

BGround = A custom keyboard image may be used here if desired.

SRCS	DSTS	KBDS	FRMS	MTX	HOT KEYS	TIE LINES	USERS	TAGS
<i>Kbd Name</i>	<i>Follows</i>	<i>Kbd(R)</i>	<i>Kbs(T)</i>	<i>Aud(T)</i>	<i>BGround</i>	<i>Rank</i>		
DESK 1-kbd		A_35	A_35		kb.jpeg	20		
DESK 2-kbd		A_39	A_39		kb.jpeg	40		
DESK 3-kbd		A_43	A_43		kb.jpeg	60		
DESK 4-kbd		A_53	A_53		kb.jpeg	80		
DESK 5-kbd		A_60	A_60		kb.jpeg	100		
DESK 6-kbd		A_67	A_67		kb.jpeg	120		

□ The FRMS (Frames) Tab

This tab is where the Drag & Drop Frame background colors, sizes and locations are defined. Refer to an RGB Color Table for more on the numeric codes.

Frm Name	Xoff	Yoff	W	H	Xscale	Yscale	Xmargin	Ymargin	BGround	Color	Border
dstsBG	21	1	78	84					#222	#fff	
macsBG	21	86	78	10					#111	#fff	
srcsBG	0.1	1	20.5	95					#222	#000	

Frm Name: In this example, dstsBG is the Destination frame, top right, macsBG is the Macro frame on the bottom right, and srcsBG is the Sources frame on the left side.

Xoff: X offset from the left, percentage.

Yoff: Y offset from the top, percentage.

W, H: Width and height, percentage.

X, Y scale: N/A

X, Y margin: N/A

BGround: Background color of the Frame.

Color: N/A

Border: This can create a border around a frame. For example, “8px solid #0f0” or “8px solid #00ff00” would yield an 8-pixel solid green border. You can also use the variable ‘dotted’ and ‘dashed’ as well as ‘solid.’

Frm Name	Xoff	Yoff	W	H	Xscale	Yscale	Xmargin	Ymargin	BGround	Color	Border
dstsBG	21	1	68.5	95					#222	#fff	
macsBG	90	0.5	9	95					#000	#fff	
srcsBG	0.1	1	20.5	95					#222	#000	8px solid #0f0

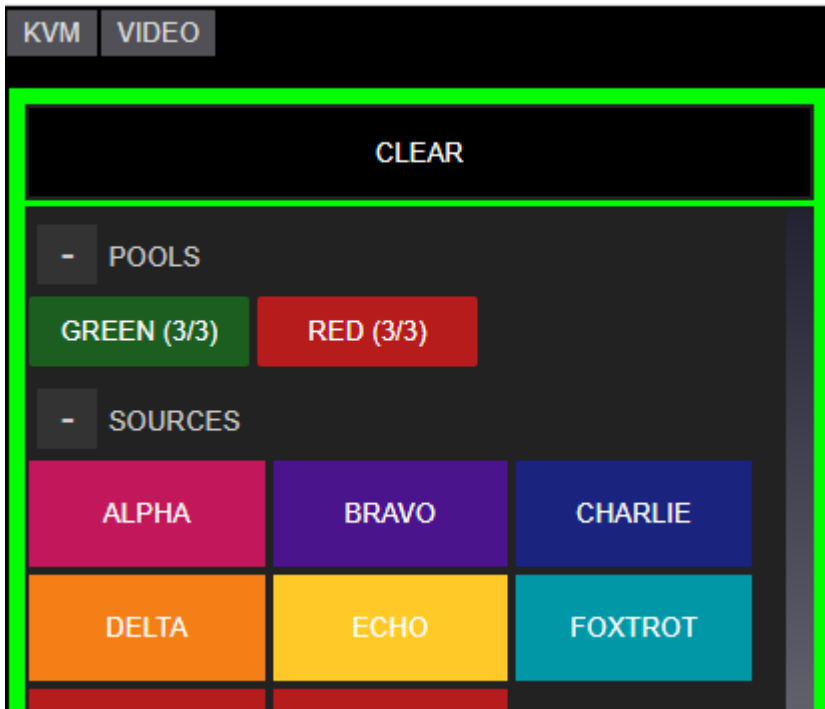

TECH NOTES: Alternate Frame location

Depending on the room layout and how it is represented in the Drag & Drop screen, it may be desirable to move a Frame. For example: It may be better to have the Macros Frame on the right side, instead of the default location of under the Destination Frame.

Here is an example of such a configuration:

<i>Frm Name</i>	<i>Xoff</i>	<i>Yoff</i>	<i>W</i>	<i>H</i>	<i>Xscale</i>	<i>Yscale</i>	<i>Xmargin</i>	<i>Ymargin</i>	<i>BGround</i>	<i>Color</i>	<i>Border</i>
dstsBG	19	0	71	100	100	100	100	100	#222	#fff	
macsBG	90.5	0	9	100	100	100	100	100	#222	#fff	
srcsBG	0	0	18.5	100	100	100	100	100	#222	#000	



Note: When upgrading from SMP2 to SMP3, and using the SMP2 configuration, the Drag & Drop geometry needs to be converted. Please contact Tech Support for the “pixel2percent” utility. Alternately, you may also change the X, Y, W and H values manually.

□ The MTX (Matrix Switch) Tab

This tab indicates the *Matrix Switch Name* (A, B, C, A1, B1, etc.), the Matrix Switch **Model** (pulldown selectable), the **IP** address of each Matrix Switch and the network **Port** (17567) used for communication with the switch. The Matrix Switch Name is used to define ports in the other tabs. For example: A__1 would be port 1 on Matrix A.

Available Matrix Switch models are listed on the right.

SRCS	DSTS	KBDS	FRMS	MTX	HOT KEYS	TIE LINES
<i>Mtx Name</i>	<i>Model</i>	<i>IP</i>	<i>Port</i>	<i>Rank</i>		
A	TLX48	192.168.13.15	17567	420		

- Model*
- MX48
- TLX12
- TLX24
- TLX48
- TLX80
- TLX160
- TLX320
- TLX640
- TLX1280
- VX40
- VX80
- VX320V
- VX640

Right click on a line to insert new lines for multiple matrices.

<i>Mtx Name</i>	<i>Model</i>	<i>IP</i>	<i>Port</i>	<i>Rank</i>
A	TLX160	192.168.13.15	17567	20

ROW ACTION

- CUT
- COPY
- PASTE
- INSERT ABOVE
- INSERT BELOW

□ The HOT KEYS Tab

This tab provides access to the Hot Key Manager and displays the default Hot Keys loaded into each extender, plus any additional Hot Keys as defined by the user.



Note: All Hot Key work is done through the USB HID port on the Thinklogical KVM Receiver. Most Thinklogical KVM Transmitters and Receivers are equipped with HID. *Hot Keys will only work on keyboards using the HID port. The USB 2.0 port does not support Hotkeys.*

Code Defaults: Default Hotkey codes are displayed here as a reference. Additional or other codes can be used when programmed into the receivers. See Appendix E: Flex Keys.

The OSD Idle Time Out is also configured on this page. Set the time-out level here. (15 min. in this example.) This feature is only used by OSDs that are configured with an optional User login. (Defined 'keyboard Users' do not need to login)

Users that request an OSD and then login will have access to sources already available to that keyboard in addition to Sources permissioned for that User (additive function).

After logging in, the user can continue to recall the OSD and still be logged in until the OSD Idle Time Out period elapses. After the OSD Idle Time Out has elapsed, the next time the OSD is requested it will only show the sources normally available to that keyboard.

Users that do not login are unaffected by the OSD Idle Time Out.

SRCS	DSTS	KBDS	FRMS	MTX	HOT KEYS	TIE LINES	USERS	TAGS	POOLS	RESTART
<i>Code Defaults</i>		<i>Key Combo</i>	CTRL + CTRL	SHIFT + SHIFT	ALT + ALT	SCROLL (twice)	OSD Idle Time Out	<i>Logout (mins)</i>		
		<i>Code</i>	11	22	44	55		15		
<i>Origin</i>		<i>Code</i>	<i>Action</i>							
*		11	OSD, 1							

HOT KEY Actions

Users can customize their system's performance and functions by programming the Hot Keys using the three columns in the HOT KEYS tab as shown below.

Origin	Code	Action
*	11	OSD, 1
*	22	MACRO, MACRO_StartUp, ...

Origin: The name of the keyboard where the Hot Keys sequence is entered. An asterisk * indicates all keyboards. Otherwise, the keyboard name that the Hotkey applies to is entered here.

Code: The Hotkey code that the SMP3 will respond to.

Action: The function(s) to be performed when the code is received. Available *Actions* are:

OSD (On-Screen Display): Allows local workstation control access giving any authorized receiver on the Matrix Switch the ability to make a change. *Example: OSD, 1* routes the OSD browser to Monitor 1. Note that a SOURCE must be a member of at least one Tag to be usable by the OSD.

CONNECT: Connects SRCx to DSTx.

CONTROL MON: Assigns KM control to DSTx.

MACRO: Run a pre-defined macro. This has the advantage of displaying a list of macros when *Details* is selected.

MACRO CYCLE: Sequentially executes one or more macros separated by commas. Each time the key sequence is entered, the program will execute the next macro in the list, then return to the first.

SHARE CYCLE: There are two modes for this operation, described below:

Src_1, Src_2 Connect first/only monitor associated with this keyboard (but not listed) to the first Source in the list (Src 2). Connect the keyboard named in *Origin* to the Source. Each subsequent Hot Key will cycle to the next Source listed, then back to the beginning.

Mon_A, Src_1, Src_2 If the first name in the list is a Destination, connect it to the second through Source names in the list. Connect the *Origin* keyboard to *Src* (like the first example, but with a named Destination as the first element).

VIEW CYCLE: Same as *SHARE CYCLE* but without the connecting keyboard.

TAKE CYCLE: Cycles through a string of 'taken' sources. Prior destinations are blanked.

CLEAR DST: Blanks the monitor at *DSTx*.

CLEAR KBD: Removes keyboard/mouse control.

CLEAR SRC: Blanks that source from all destinations.

COLLABORATE: Allows multiple users to easily exchange a single Source's KM controls. Note that Collaboration must also be enabled in the receiver modules. There are two types of Collaboration, switching via mouse or via keyboard (or both).

*	6b	COLLABORATE, 1
*	6d	COLLABORATE, 1

Code 6b is used for mouse.

Code 6d is used for keyboard (space invokes it).

TOGGLE: Reset the Monitors/Destinations associated with this keyboard to their previous Sources. Alternates between two previous Sources called from the OSD.

CAST: Duplicates video on the 'From' destination to the 'To' destination.

MIRROR: Links one Monitor/Destination to one or more additional "mirrored" Destinations so that any time a Source is connected to the first Monitor/Destination, the same Source will also be connected to the remaining Monitors/Destinations.

Mon_1, Mon_2, Mon_3 Any time a Source is connected to Mon 1, it is automatically connected to Mons 2 and 3.

MIRROR OFF: Turns off mirroring.

INT MOUSE: Enables the **Intuitive Mouse** feature and shows a list of monitor names describing how the monitors are arranged. Commas separate monitors, and slashes (/) separate rows. *Examples:*

Desk_1, Desk_2 Two Desks, left and right.



Desk_1 / Desk_2 Desk 1 is on the top row; Desk 2 is on the bottom.



Desk_1, Desk_2 / Desk_3, Desk_4 Two rows: Desk 1 and 2 are on the top row and Desk 3 and 4 are below.



Desk_1, Desk_2, Desk_3 / Desk_4, , Desk_6 Two rows of three with a blank space in the bottom where Desk 5 would be (signified by empty space between the commas).



Note: Intuitive Mouse must be enabled in the extender modules. See Appendix H.

IGNORE: Causes a command to be ignored. This is used to exclude a destination from a wildcard (*) hotkey. (Enter the keyboard and the Code to be ignored.)

Adding HOT KEY Functions

Add additional Hot Key functions by right-clicking on a field. For example, select INSERT BELOW to add Hot Keys. (See *Appendix D: Enable Hot Keys*, and *Appendix E: Flex Keys*).

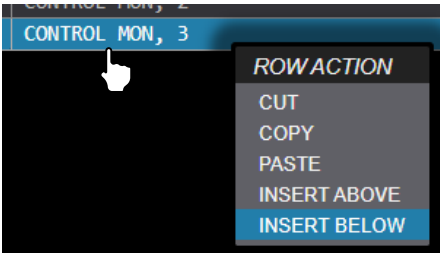

A new row will appear below the row selected.

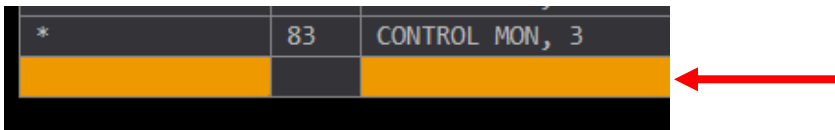

Origin: Left-click to select a keyboard from the drop-down menu. (* = all keyboards)

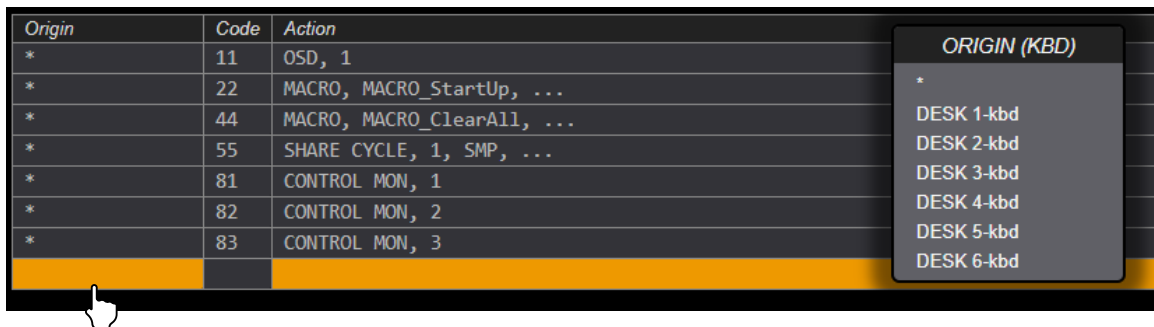

Code: Left-click within the Code field. Type in a hexadecimal key combo as shown below. (In this example code '88' was chosen for a new hotkey function.)

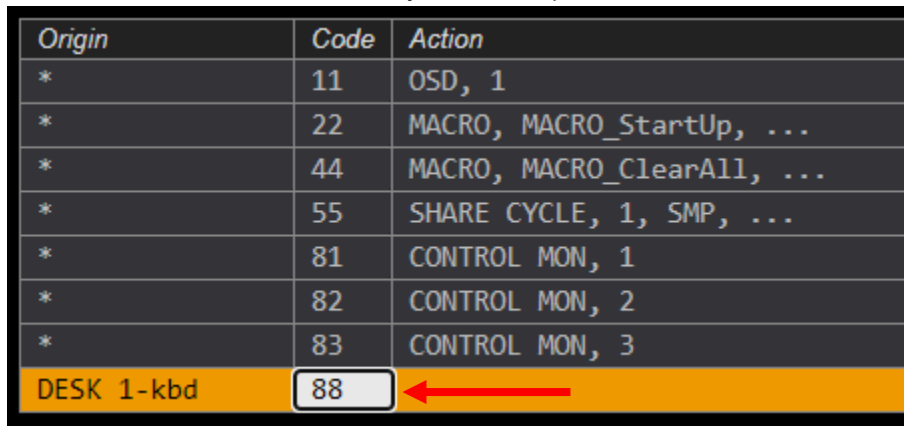

Note: Certain Hotkey Codes should be avoided:

If Intuitive Mouse is used in the extenders then avoid using codes: 62, 6c, 72, 74 for other purposes.

If Collaboration is used in the extenders then avoid codes: 6b, 6d.

Also avoid codes: ff, 7f and 3f as they can be generated by a monitor going to sleep.

Action: Left-click within the Action field. Select from the drop-down menu.

Code Defaults	Key Combo	CTRL + CTRL	SHIFT + SHIFT	ALT + ALT	SCROLL (twice)	OSD Idle Time Out	Logout (mins)
	Code	11	22	44	55		15

Origin	Code	Action
*	11	OSD, 1
*	22	MACRO, MACRO_StartUp, ...
*	44	MACRO, MACRO_ClearAll, ...
*	55	SHARE CYCLE, 1, SMP, ...
*	81	CONTROL MON, 1
*	82	CONTROL MON, 2
*	83	CONTROL MON, 3
DESK 1-kbd	88	<input type="text" value=""/>

COMMAND

OSD

CONNECT

CONTROL MON

MACRO

MACRO CYCLE

SHARE CYCLE

VIEW CYCLE

TAKE CYCLE

CLEAR DST

CLEAR KBD

CLEAR SRC

COLLABORATE

TOGGLE

CAST

MIRROR

MIRROR OFF

INT MOUSE

IGNORE



TECH NOTES: *Hotkey via mouse - "MsSwitch Toggle" setting in TLX receivers*

There is an additional feature available in TLX series receivers known as "MsSwitch Toggle" which can be enabled (default is disabled). This is used in conjunction with 5 button mice. When enabled the receiver will send a Hotkey code of '99' when the left mouse button is pressed along with the front side button. The receiver will send a Hotkey code of '98' when the left mouse button is pressed along with the back side button. Therefore, when enabled, Hotkey Actions can be configured for these Hotkey codes.

Receiver LCD menu, select Yes to enable:

MsSwitch Toggle
Mode = No

□ The RESTART Tab

This is a convenient way to restart the SMP3 server after certain conditions, such as when making edits or changes to the system that may require the system to restart.

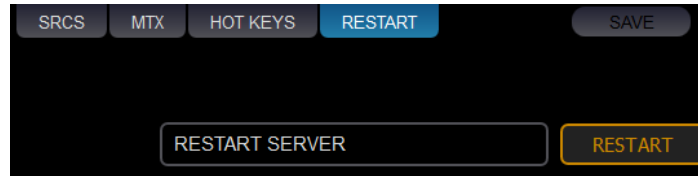

Note: A Restart is not required after doing all changes. For example, changes affecting the Drag & Drop page may only need a browser refresh (F5) to display correctly.

□ The TIE LINES Tab

Tie lines provide a means for connecting sources and destinations across two or more Matrix Switches. This tab displays the tie lines that connect Matrix Switches together. Tie lines are typically bi-directional, providing video and data Tx to Rx and back-channel data Rx to Tx.

To create tie lines, right click in the field and select NEW.



A pair of unnamed Matrix Switch icons will appear.

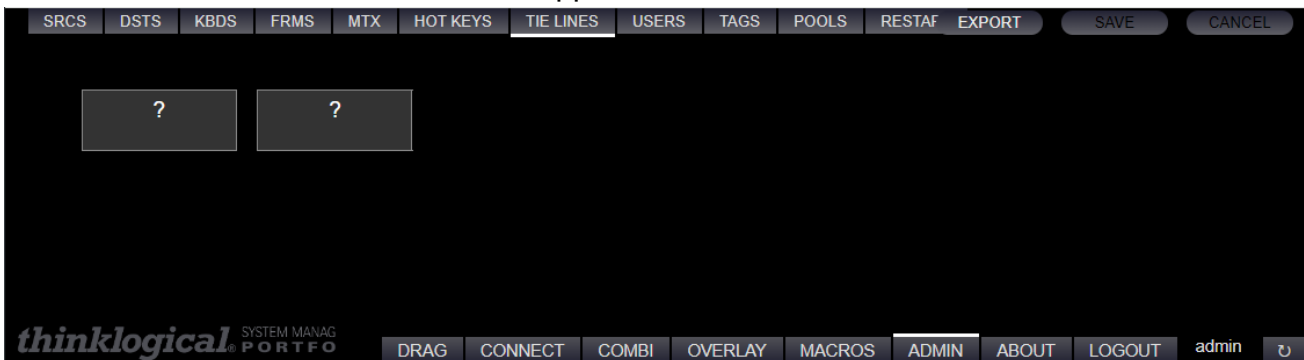

Click within a Switch icon to select from the list of Matrices predefined in the MTX tab.

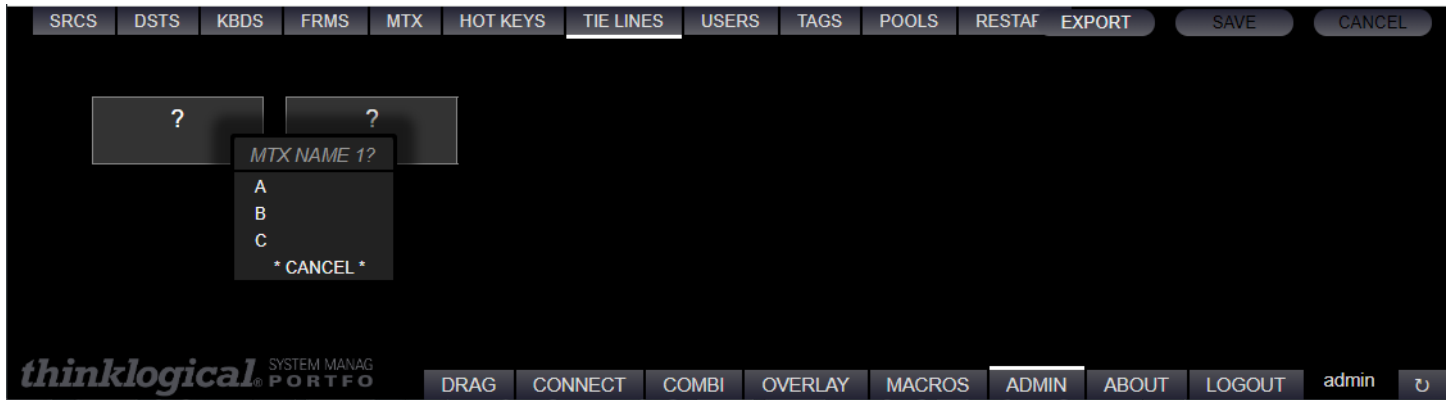

Once the Switches are named, right click within an icon to select a tie line for either direction. Selecting NEW DUPLEX will create a bi-directional tie line using the T and R of the same SFP. Port numbers can be specified in the white fields in each Switch icon. Click **SAVE** to preserve changes.

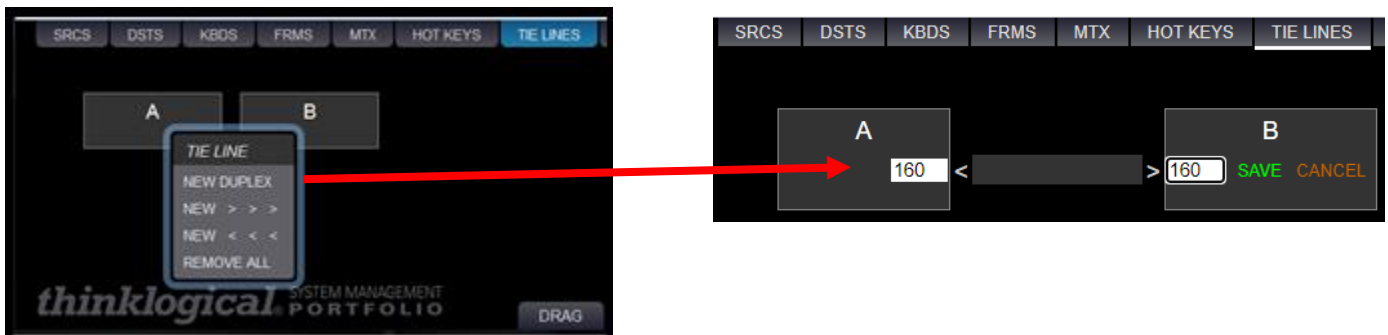

Add tie lines to as many Switches as needed.

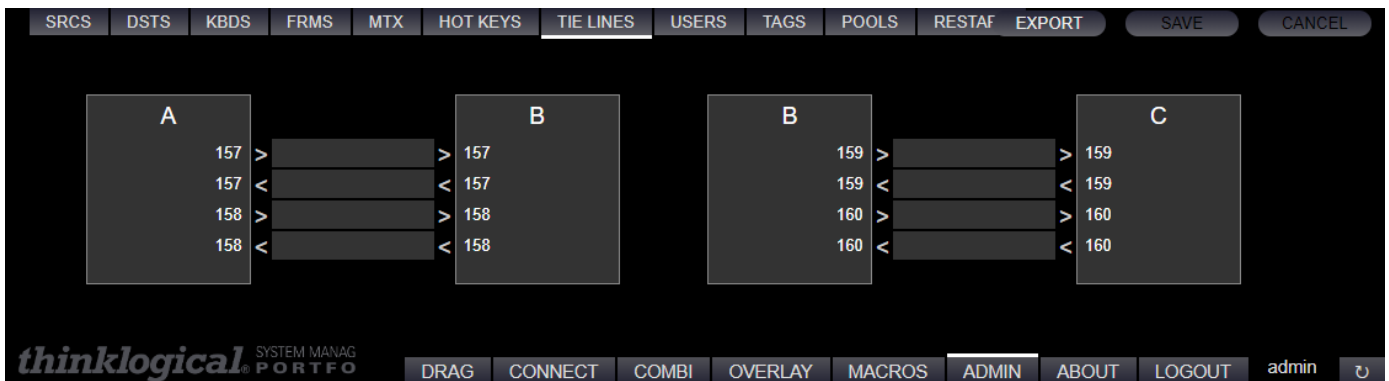

After the tie lines are created, users may click on them for a new menu: CLEAR, DELETE, AUTO, *MANUAL*. Selecting AUTO is required for the SMP3 to automatically use an available tie line when making routes. The *MANUAL* selection is used when the tie line is to be used by a third-party control system (such as AMX or Crestron, etc.).

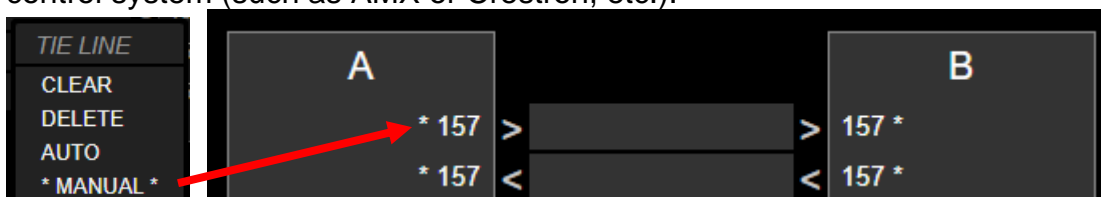

□ The USERS Tab

USERS defines which assets; Pools, Sources, Destinations, Macros and Tags are available to the three user types*. This tab displays the Users on the left USER/KBDS and which assets are available on the right under USER DETAIL. When a new keyboard is added under the KBDS tab, it also needs to be added here.



*Right clicking in the left frame will display a menu to select one of **three user types**.

NEW USER (optional, not required) This type of user applies to systems where asset availability is controlled by a log-in, such as the OSD, Touchpanel and when logging into the SMP3 via a browser over the network. Selecting this item displays a window where a username is entered.

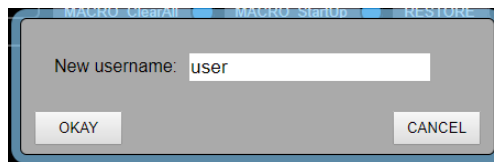

The default password for newly created users is also the username. To change this password, see *How to Create or Modify a User or Password*.



Special Note for OSDs and Touchpanels: Typically, assets are assigned to a KBD USER or TOUCHSCREEN User, and these will be displayed at the proper location. Optionally however, a USER may be created with their own assets. Then when that USER logs in to an OSD or Touchpanel, their assets **will be added to** the default assets already present.



Note: The SMP3 supports a User named “api.” This is used for API access to the SMP3 for various functions and this name is reserved for that purpose. See Appendix J.

The username that is currently logged in to the SMP3 will be displayed in the lower right corner.

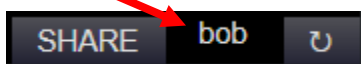

KBD USER: Keyboard User applies to the physical keyboard and its location at a workstation console. Selecting this will display a menu of available KBD Users to choose from. Assets added to a Keyboard User will apply to OSDs and Touchpanels. These assets also include the START PAGE (first page to be displayed) as well as PAGES (these will appear as button selections on the bottom).



Note: If the KBD names have been changed in the KBDS tab, then they also need to be updated [here](#).

TOUCHSCREEN: This is where Thinklogical Touchpanels are added and configured. The Touchpanel name (default name is LOBBY) and the IP address of the Touchpanel are entered here. This is the IP address of the Touchpanel at the Desk. The resulting USERS/KBDS icon will display this name and indicate that it is a Touchpanel by the **(ip)** prefix.

Right Click in the USERS / KBDS window, then Click on TOUCHSCREEN in the resulting drop-down menu.

Enter a Name and an IP address for the added Touchpanel, then click on OK.

Touchscreen Name@IP:
TP2@192.168.13.113
OKAY CANCEL

The new Touchpanel will appear in the USERS / KBDS window.

Select the desired SRCS, DSTS, POOLS, TAGS and MACROS to display on the new Touchpanel.

START PAGE Select the page the Touchpanel will display when booted up.

PAGES Select the page icons you wish to appear at the bottom of the Touchpanel.

Click SAVE.



Note: After adding the Touchpanel to your USERS tab, make sure to also select an item in the START PAGE row in the USER DETAIL section. Otherwise, the Touchpanel will be blank when it is powered up. (See the Touchpanel manual for installation information.) It is also recommended to have at least two selections under Pages. For example: LOGOUT and ABOUT, as well as those you require.

Example of a Touchpanel with DRAG as a Start Page and DRAG, CONNECT and COMBI pages available.

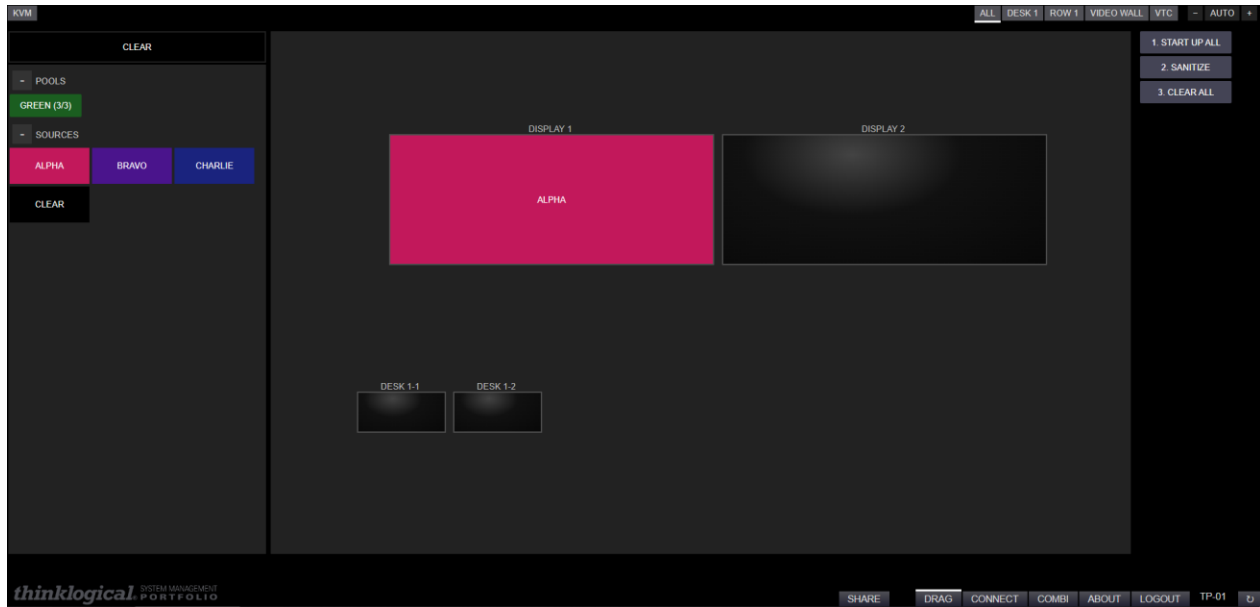

Note: The behavior of the Drag & Drop page is affected by the [SHARE] tab settings on the bottom of the page (see Drag and Drop section).



Option: You can change the SMP3 URL so that the TAKE option is not displayed on the CONNECT page. This is for sites that never want to inadvertently enable the TAKE feature. Simply append the string “indexNT.html” to the URL.

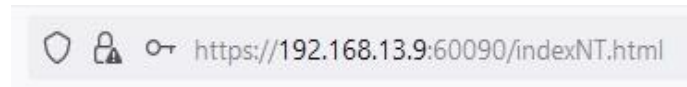



The TAKE button will then not be available.



For more information on installing Thinklogical Touchpanels see:
[Manual_PoE_Touch_Panel_Rev_B.pdf](#)

Assets: Once a new User is added, assets are then made available by selecting the appropriate colored-coded dot. In the case of *Sources*, there are two dots, defined as follows:

- Mac-1  Source is not available to this User
- Mac-1  Source can only be viewed by this User
- Mac-1  Source can be viewed by this User and has keyboard control access



Note: To restrict assets (if necessary) via OSD or user login:

- 1) Deselect all assets for the kbd-user.
- 2) Enable selected assets for a User (otherwise they will be added together).

The right frame, **USER DETAIL**, has six categories that can be configured:

- PAGES – These are the pages that will be available on a Touchpanel or web server login for the operator to choose from. These options will appear as tabs at the bottom of their screen.



Note: When assigning Pages to a Touchpanel User, it is recommended to have at least two Pages selected. For example: About or Logout in addition to what is required, like Drag.

- START PAGE – Only one category may be configured here. This is the first page an operator will see upon Touchpanel, OSD or web server login.
- POOLS, SRCS, DSTS, MACROS – System assets that can be made available to a User.
- TAGS – If nothing is selected here then all Tags will be available to a user if they have any asset contained within that Tag. However, if Tags are selected here then only the selected Tags will appear for that User. This is useful if many Tags are created but a User only needs to use a subset of them (for convenience). For example, you would want a minimum of Tags to be displayed on a Touchpanel to avoid or minimize scrolling in the Tag area.

The DSTS frame also has two color coded dots to be configured. These can be used to define Push and Pull privileges.

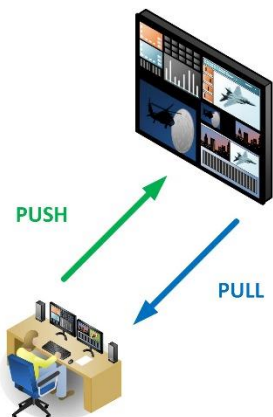

Both = Full access, the same as in previous SMP versions.
 Blue = Pull only. Allows a user to Pull video from another Destination.
 Green = Push only. Allows a user to Push video to another Destination.

Click on SAVE to activate the change or CANCEL to discard changes.



The **USER DETAIL** area has additional menus available for ease of configuring. Right-Clicking in the SOURCES frame will yield the illustrated menu.

For example: FILTER allows you to filter the display of a subset of Sources by defining what to filter by. Choose SHOW ALL to undo the FILTER.

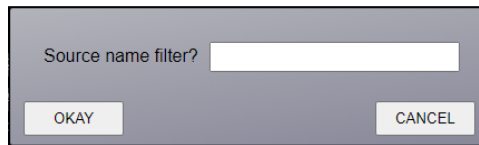

Note: If a Source is a member of a Pool, then it is not recommended to assign the non-Pool Source Asset to a User that **also** has that Pool as an Asset. This would defeat the purpose of pooling. However, you could create Users with Pooled Assets and additional Users using the same Assets in a non-Pooled fashion.

□ The TAGS Tab

TAGS creates **named sub-sets** of Sources and/or Destinations that belong to a specific group. It can be thought of as a “display filter.” This is useful in larger systems with many sources and destinations. TAGS will be displayed and used on the DRAG & DROP, CONNECT and COMBI pages.

- Right click in the TAGS/CATEGORIES area to create a new TAG.
- TAGS that consist only of Destinations will be displayed on the right on the D&D or CONNECT pages and in the center of the COMBI page.
- TAGS that have **one or more** Sources will be displayed on the left on the D&D or CONNECT pages and at the top of the COMBI page.
- A Pool may be part of a TAG.
- Right clicking on a TAG will allow renaming or deleting a TAG.



Note: A SOURCE must be a member of at least one TAG to be usable by the OSD.

Example of a Tag to display only one row of desks:

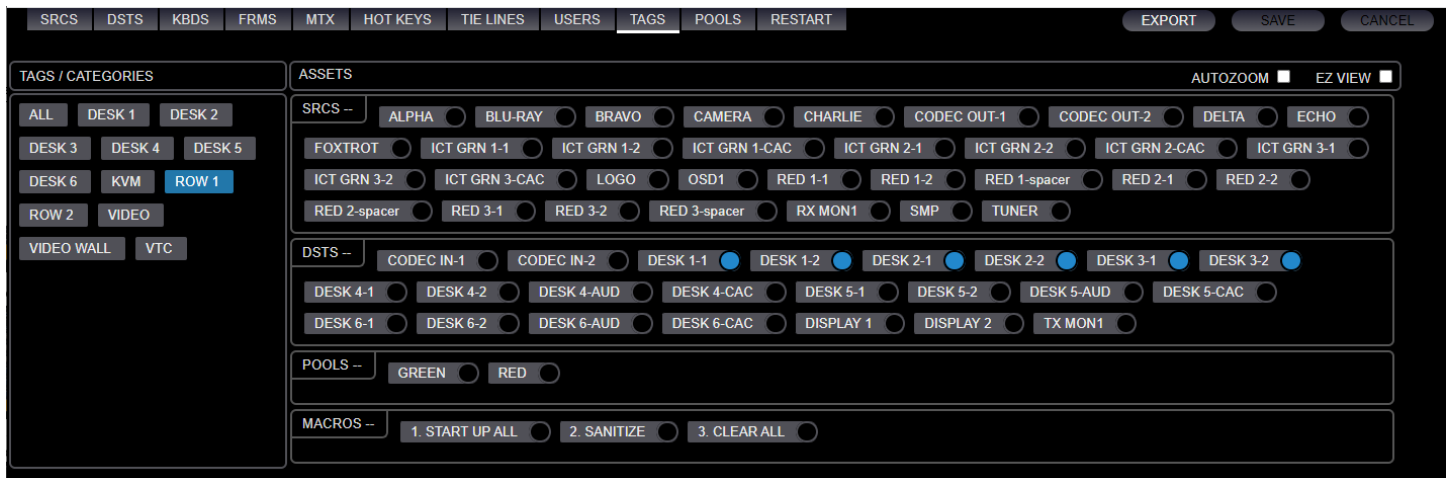

□ AUTOZOOM and EZ view

There are two options in the USERS tab and the TAGS tab for AUTOZOOM and EZ VIEW. They are available in both tabs so that this feature can be applied to single TAGS or single USERS (such as keyboards or Touchpanels). This will affect the appearance of the Drag & Drop display for that TAG or User. When enabled the SMP3 adjusts the display of the Destination assets for the best fit. This is useful in larger installations where the icons are much smaller and farther apart than our simple example below.



To illustrate how these features perform, first consider the entire Drag & Drop page for a small system (all Destinations).



AUTOZOOM

AUTOZOOM takes the assets and sizes them to fill the frame.

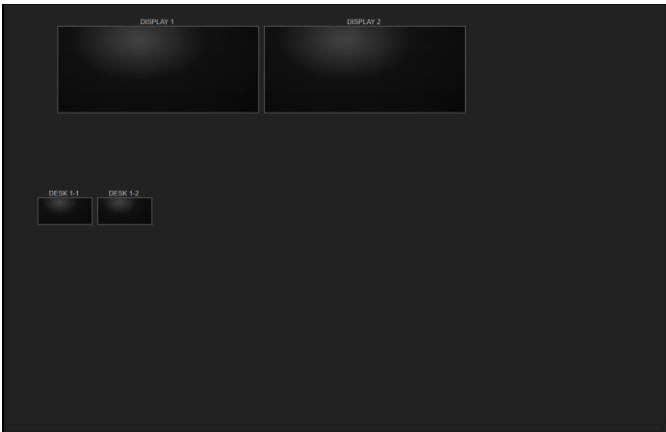

AUTOZOOM off Desk 1 = Normal size

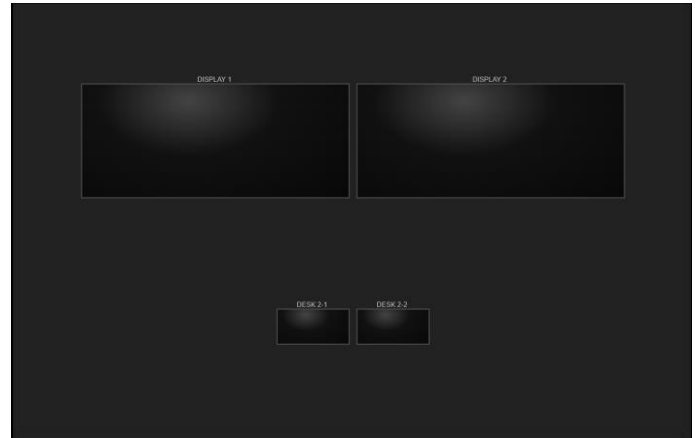

AUTOZOOM on Desk 2 = Assets fill the frame

Here we see the advantage of AUTOZOOM for Desks 1 and 2.

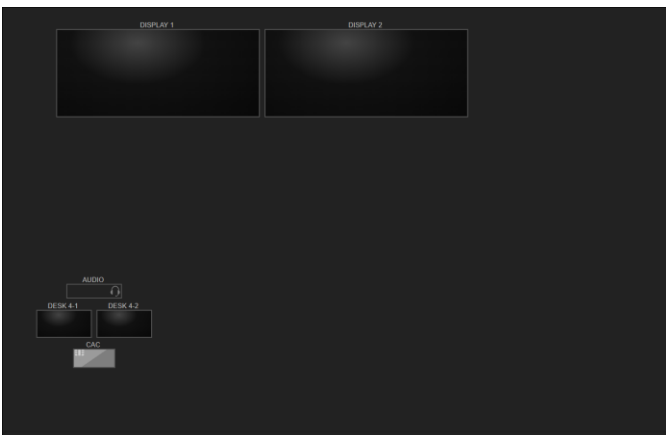

AUTOZOOM off Desk 4 = Normal size



AUTOZOOM on Desk 6

Here we see that the right image is larger but not that different. This is because Desks 4 & 6 are at a distance from the wall displays.

EZ View

EZ view provides a better fit in certain cases by removing some of the space between icons.



EZ view off Desk 6 = Normal size

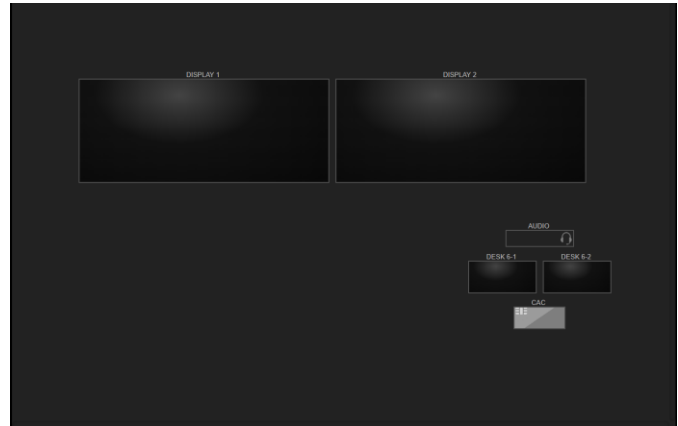

EZ view on Desk 6 = Assets fill the frame better



Note: AUTOZOOM and EZ view may also be combined. The ideal configuration will depend on the site.

□ The POOLS Tab

This tab displays the Pools that have been created by an administrator and the Sources assigned to each Pool. A Pool is a set of Sources that all perform the same function (i.e., graphics processor, thin client, etc.). Sources must first be defined in the SRCS Tab prior to creating Pools.



Note: Pools are used via the Drag & Drop page, including a Touchpanel or OSD with Drag & Drop enabled. Pools are not supported on the Connect or Combi pages.

An example of adding a Pool is shown below:

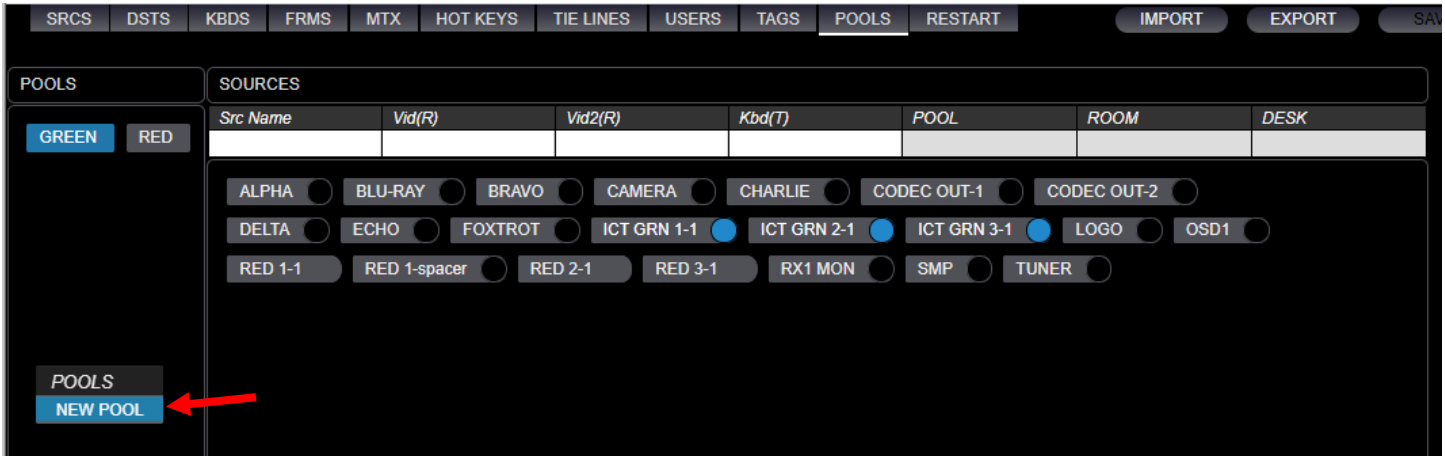

Right-click in the empty POOLS area and select NEW POOL from the drop-down menu. Enter a name for the new pool: For Example: “CODEC”, then click OK.

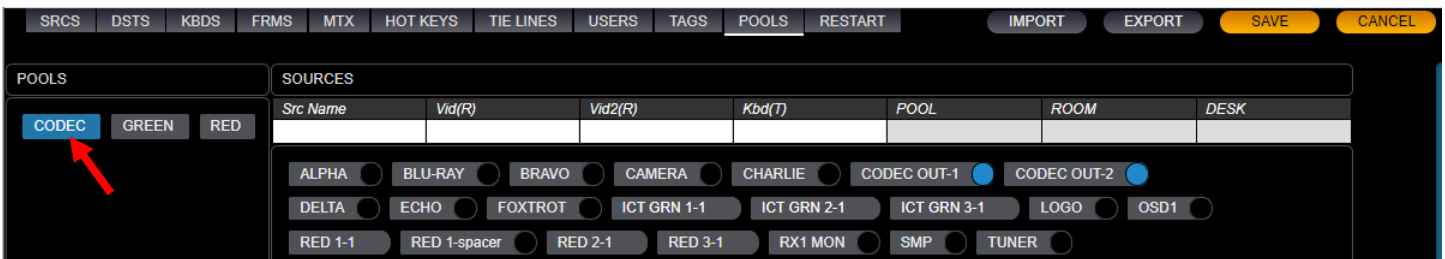





This Pool has been created and named “CODEC”. Select this new Pool and choose the SOURCES to be added, then click SAVE.



Warning! Once assigned to a Pool, a source should not be used as a separate source; this would defeat the purpose of Pooling. However, there is an exception, see Users tab section above.

Pool buttons are color coded to display their status:

- Src A1  Assigned to the displayed source pool.
- Src A1  Available.
- Src A1  Allocated to a source pool other than the currently displayed pool.
- Src A1  Allocated to a source pool and Reserved. (Can only be used by the user who reserved it.)

Example of POOL status buttons:

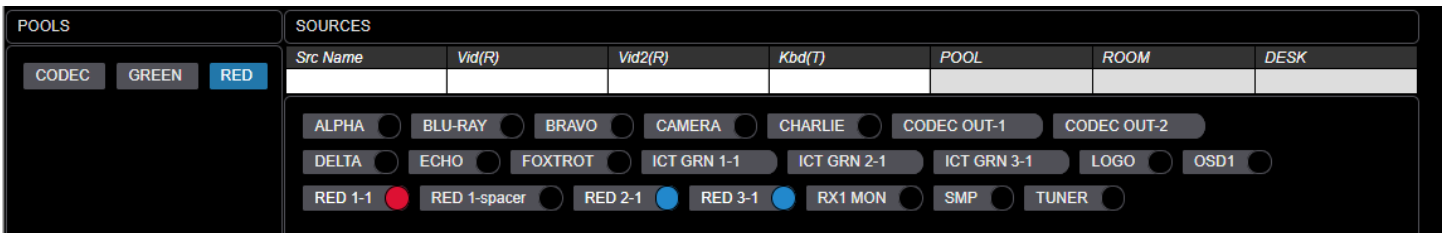

POOLS – Optional feature

The SMP can be configured to generate a warning message prior to a Source being Published. To enable this feature, first add an Alert column to the SRCS page. This is best done by exporting the “stations.csv” file and editing it on a PC using Excel.

Src Name	Follows	Primary	Vid(R)	Vid2(R)	Kbd(T)	Kbs(R)	Aud(R)	EDID(T)	IPIVd(T)	IPIVs(R)	Alias	BGround	Color	X	Y	W	H	Level	Rank	Alert
ALPHA			A_1	A_2	A_1	A_1	A_1					#C2185B	#fff			32	15	1	30	
BRAVO			A_3	A_4	A_3	A_3	A_3					#4A148C	#fff			32	15	1	40	
CHARLIE			A_5	A_6	A_5	A_5	A_5					#1A237E	#fff			32	15	2	60	
DELTA			A_7	A_8	A_7	A_7	A_7					#F57F17	#fff			32	15	2	80	
ECHO			A_9	A_10	A_9	A_9	A_9					#FFCA28	#fff			32	15	3	100	
FOXTROT			A_11	A_12	A_11	A_11	A_11					#0097A7	#fff			32	15	3	120	
RED 1-1			A_13	A_14	A_13	A_13	A_13				RED 1 VIDEO 1	#B71C1C	#fff			32	15		140	SIPR source #1
RED 1-2	RED 1-1	RED 1-1	A_15	A_16	A_13	A_13	A_13				RED 1 VIDEO 2	#B71C1C	#fff			32	15		160	

Then when this Source is about to be published, text in this cell will be displayed as in this example.



POOLS – Administrator Functions

Reservations & Flags

The Administrator can determine who has a Pooled Source reserved and has the ability to release the Source(s) back into the Pool. For example: User “user1” has Source “ICT GRN 2-1” reserved below (circle is red). Left clicking on the Source name will display details in the fields above.

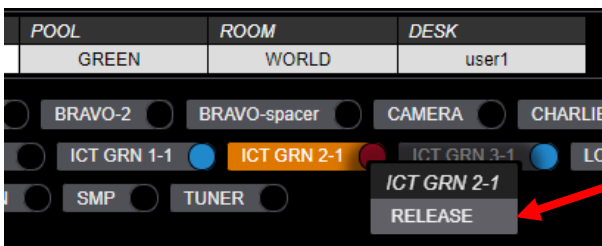
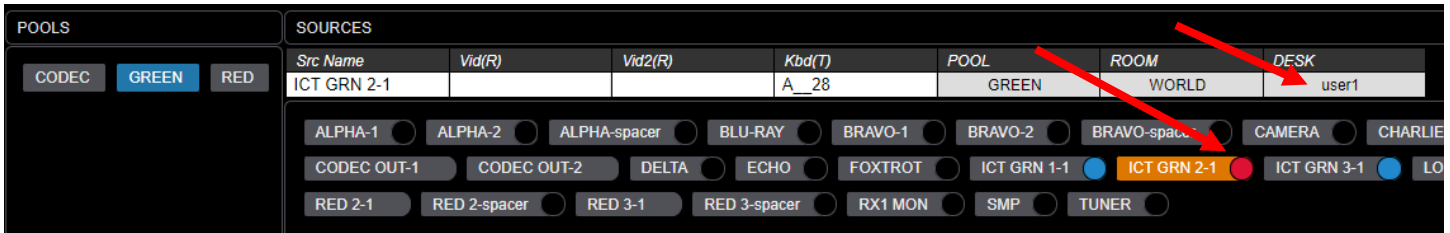

Right clicking in the red circle will allow the Administrator to release that Source back into the Pool.

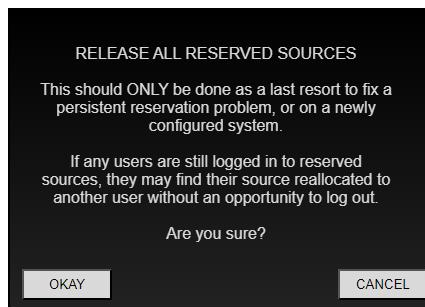
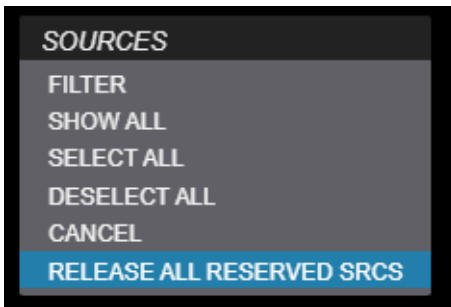

Right clicking in the space between the Sources will allow the Administrator to release all Sources. A warning message will pop up.

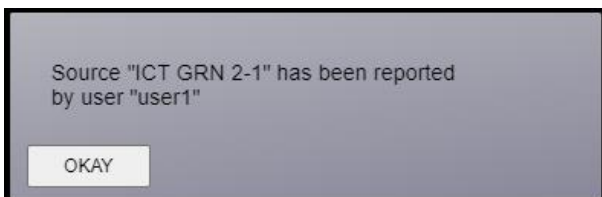

If a User should Flag a Source as problematic, the Administrator will get a notification.



The Administrator will also see this Source displayed in red and can clear the Flag by right clicking on the Source name.

TECH NOTES: *Unexpected POOLS on the OSD*

During the installation or reconfiguration of a system, unexpected POOLS may be displayed in the OSD Source area.

The SMP POOLS are deliberately designed to maintain reserved sources through a restart or power cycle or switchover to redundant SMP. Therefore, when pools disappear (removed or through setup modification/replacement) without first releasing all the reserved sources in those pools, this may result in "leftover" information.

To prevent this from occurring be sure to release all reserved Sources before doing any modifications.

□ The MACROS Tab

A macro is a set of programmed connection instructions that execute automatically with a single command. The **MACROS** Tab is used for displaying and creating Macros. These Macros are stored in the system in the /opt/tl/setup/macros directory.

The default SMP3 configuration comes with three pre-installed macros as examples. These are labeled “1. **START UP ALL**,” “2. **SANITIZE**,” and “3. **CLEAR ALL**.” These can be deleted, changed or additional macros can be added. Note these default names are preceded by a number to display them in that order, the numbering is not a requirement. Otherwise, MACROS will be displayed in alphabetical order.

Right-click anywhere on the screen to get the drop-down menu for adding new macros.

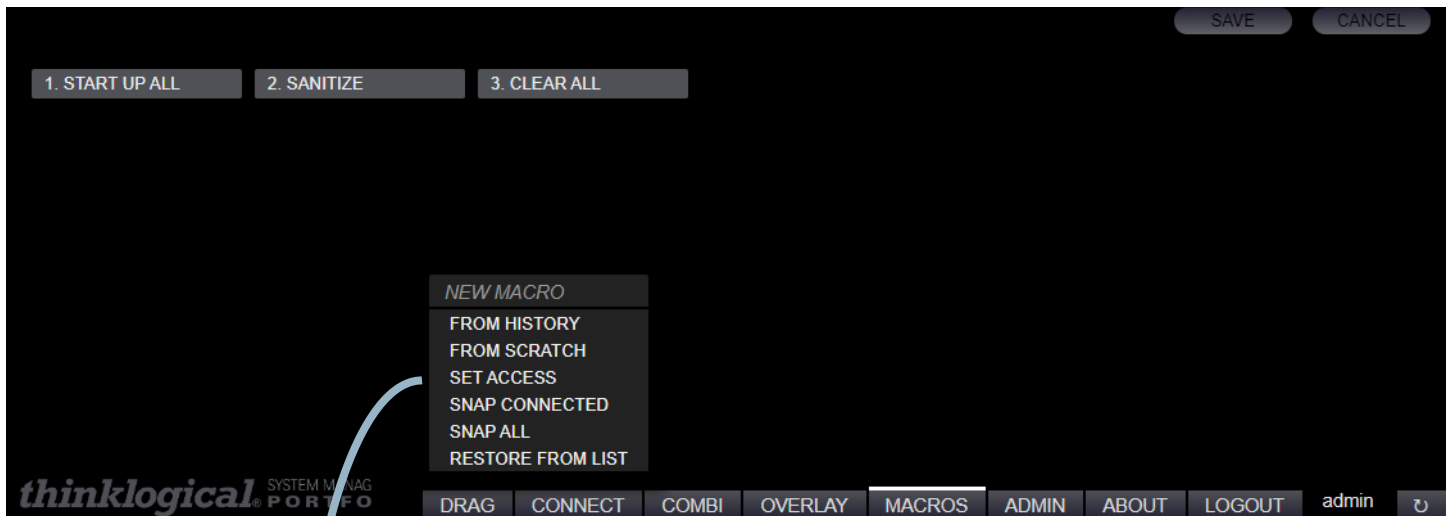

NEW MACRO

- FROM HISTORY
- FROM SCRATCH
- SET ACCESS
- SNAP CONNECTED
- SNAP ALL
- RESTORE FROM LIST

FROM HISTORY Opens the history log and allows commands to be selected from the log. Note that this may be a very large log. One option to make the log more wieldy is to clear the long history, perform the desired operation(s), then create a macro from the new, briefer history.

FROM SCRATCH Allows commands to be entered one by one. Normally the best option for simple macros.

SET ACCESS Creates a macro that sets an access level for the Matrix Switch. Choose the desired level (with “1” being the highest). Add the macro to the DST tab to have it show on the drag screen. NOTE: This does not override the levels previously configured in the SRCs and DSTs.

Optional: Add a RESTORE line to this macro to:

- Generate a DROP-DOWN (if no level is entered on the RESTORE line)
- Go to another level (if a level number is entered on the RESTORE line)

SNAP CONNECTED Creates a macro of actual routed connections. NOTE: This does not include un-made connections; ie: disconnections.

SNAP ALL Creates a macro of actual routed connections AND disconnections. This is the current state of the switch.

RESTORE FROM LIST Creates a macro that restores the system to an access level that can be selected from a drop-down menu. This list is added to when dropping down a level using the SET ACCESS macro above. This is used to restore to a prior level after temporarily dropping down a level.

Pick the **FROM HISTORY** option to use previous operations. Connections that have been created historically from the Connect page or from Drag & Drop will appear here. *This will likely be a long list.* Select all actions to be included in the macro. Some **CONNECT** entries will have a **CONTROL** line below it. Selecting a **CONTROL** line gives KM control to that connection.

Pick the **FROM SCRATCH** option to create a new Macro by adding new commands as required. Enter a name in the [macro name here] field.



When choosing **FROM SCRATCH**, an Action line appears below the macro's name. Left-click on **COMMAND** and a drop-down menu appears. Here Actions, Sources and Destinations are defined manually. For example, select **CONNECT** as below.

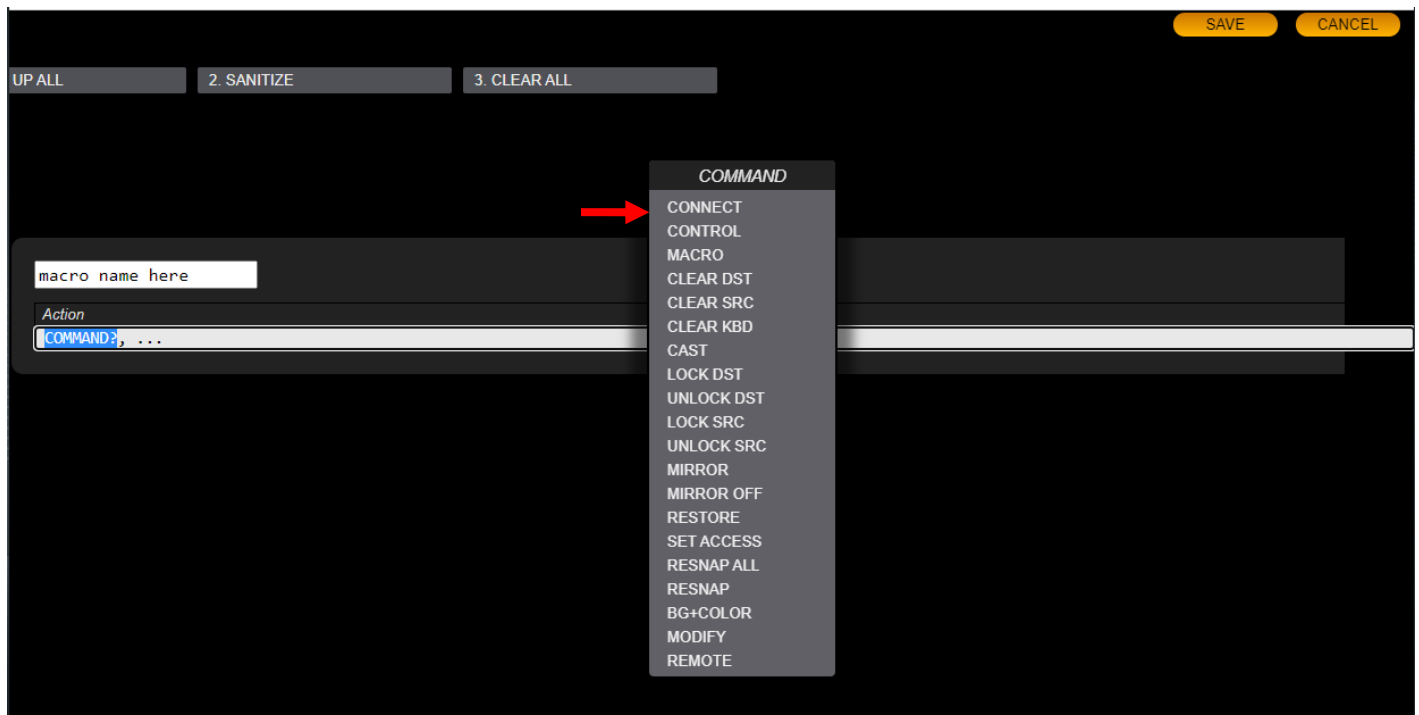

MACRO Actions

Action	Function
CONNECT	Connects the video from a Source to a Destination.
CONTROL	Connects keyboard & mouse control from a Destination to a Source.
MACRO	Allows this Macro to invoke another Macro.
CLEAR DST	Clears video, keyboard & mouse from a Destination.
CLEAR SRC	Clears all Destinations this Source is connected to.
CLEAR KBD	Clears the keyboard & mouse from a Destination.
CAST	Connects video from a Destination, to another Destination (such as a video wall) and keeps that connection until cleared. (see also Mirror)
LOCK DST	Locks a Destination; prevents other Sources from being connected.
UNLOCK DST	Unlocks a previously locked Destination.
MIRROR	Connects video from a Destination, to another Destination (such as a video wall). The second Destination will display other Sources that may be connected to the first Destination.
MIRROR OFF	Turns off the Mirror function.
RESTORE	Creates a new Macro that will generate a pop up list. This list will contain access levels that were previously used when changing levels. See SET ACCESS below.
SET ACCESS	Sets the access level of a site, or of an area defined by a TAG. Also provides the option of switching to another Source such as a fixed image.
RESNAP ALL	Automatically updates an existing Macro of all the Matrix Switch connections <i>and disconnections</i> . The TAG field is used to limit this activity to Destinations within the named TAG. This is useful for example to limit it to a particular room.
RESNAP	Automatically updates an existing Macro of all the active Matrix Switch <i>connections</i> . The TAG field is used as above.
BG+COLOR	Place at the top line of the MACRO definition. This provides for setting the background (first variable) and text (second variable) colors of the MACRO icons. See below.
MODIFY	Dynamically add or remove destination assets within a Tag. May be used to replicate video wall layouts when used with duplicate destinations with different geometry. Also, useful to show or hide multiple destinations which occupy the same X/Y coordinates.
REMOTE	Send a control command to a third-party device like a video wall processor or camera. Requires an understanding of supported API commands of external device. Works with IP device on the same network as SMP and does not require authentication.

The BG+COLOR Action:

The syntax is: BG+COLOR, #<background color>, #<text color>.

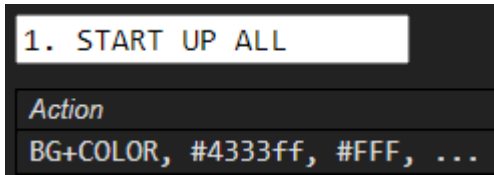

For example:

Will yield:



The Action will now display CONNECT, SRC?, DST?, ... Left-click on SRC? and another drop-down menu appears. Choose a source name from the menu. Likewise, left-click on DST? and choose a destination name from the drop-down menu. Left-click on ... to select more *Destinations*. Click **SAVE** to keep changes.

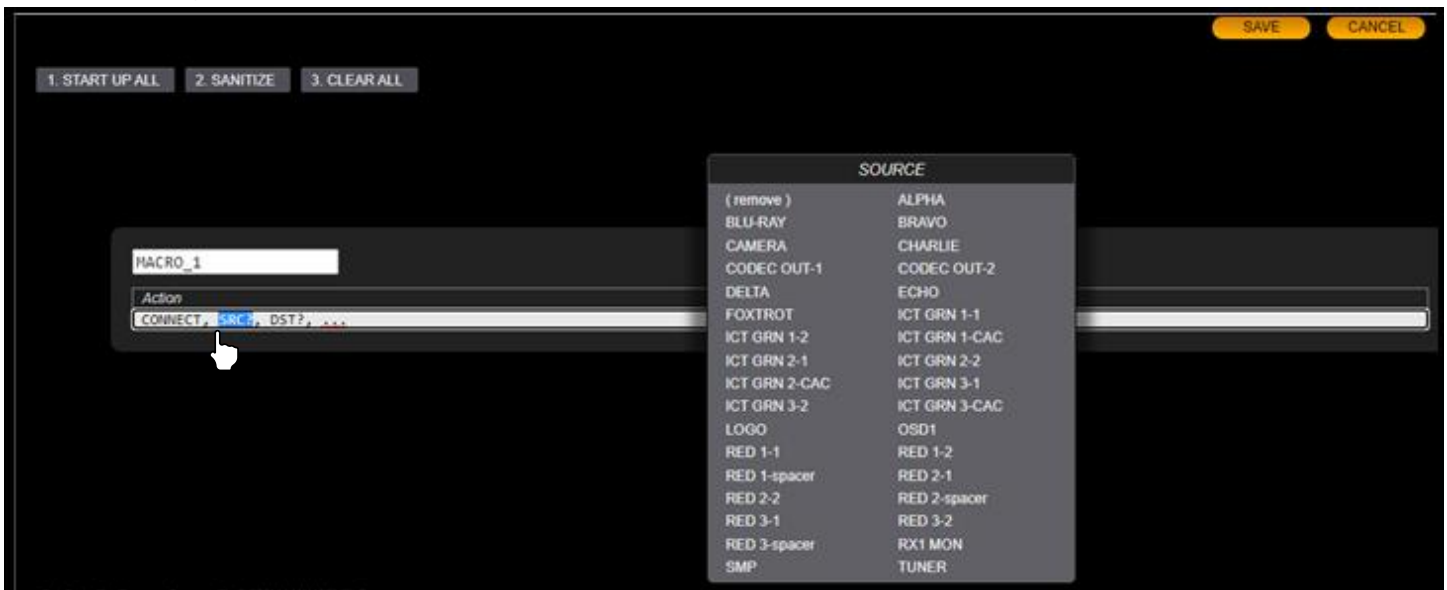

MACRO_1 now appears along with the original macros and can be executed with a single click.

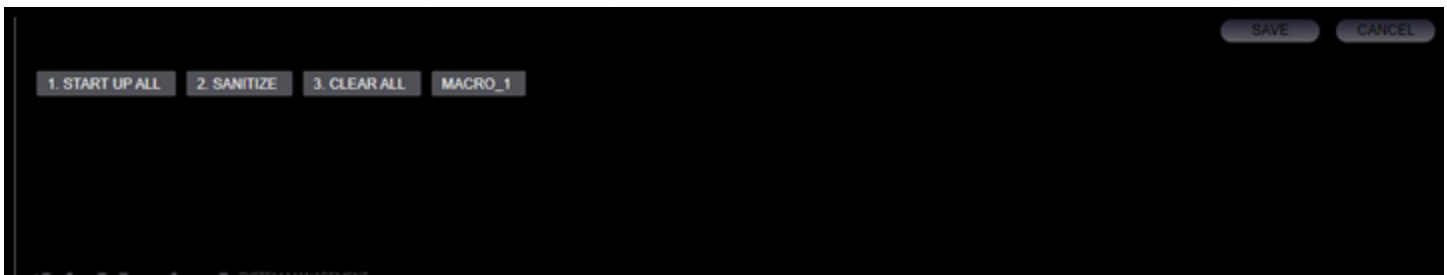

Pick the **SET ACCESS** option to create a new Macro that will set the access level of your Sources.

- Click on **LEVEL** to choose the Access Level. These relate to the values in the Level column of the Sources and Destinations. Example = 2.
- Click on **REPLACEMENT SRC** to select the Source that will be switched to the Destinations when the Macro is invoked. Example = LOGO.
- Click on **TAG** to select the tagged Destinations the Macro should apply to. The Tags need to be defined previously. If you wish the entire site to be affected, then create a Tag (Example: "ALL") for the entire site. Example = ROW 1.

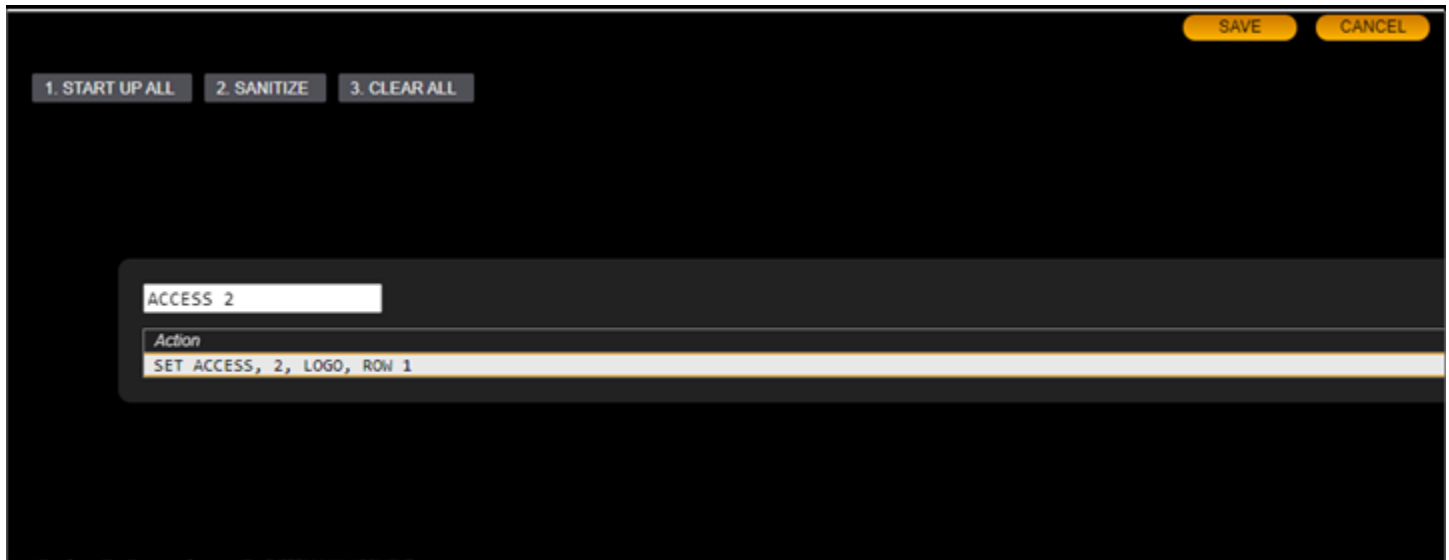

Pick the **SNAP CONNECTED** option to automatically create a Macro of all the current Matrix Switch connections.



Pick the **SNAP ALL** option to automatically create a Macro of all the current connections AND disconnections. This may also be thought of as the current state of the Matrix Switch.

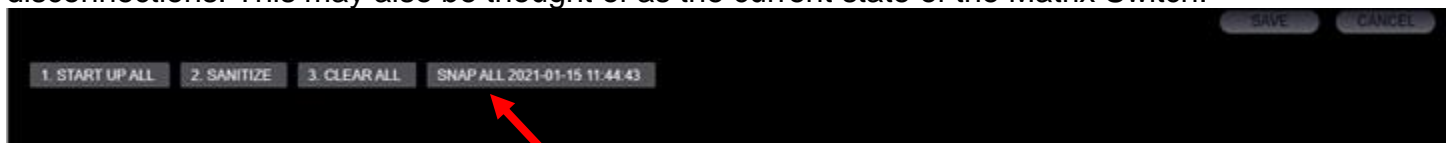

Pick the **RESTORE FROM LIST** option to create a new Macro that will generate a pop up list when used. This list will contain access levels that were previously used when changing levels.

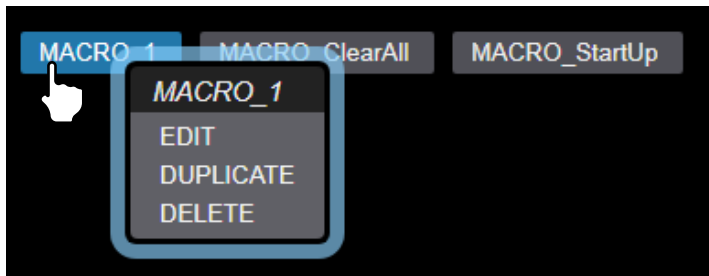

A MACRO can be **edited, copied, or deleted** by right-clicking on its name, then choosing from the drop-down menu.



Note: The default location for the Macro icon is in the Drag & Drop **MACRO** frame (see FRAMES above). However, this icon may be *moved* to the Destinations frame. To do this, first create the **MACRO** as described in this section. Then prefix the MACRO name with “MACRO_”. Then create an entry in the Destination tab for the MACRO. You may also wish to give this MACRO an Alias name.

Example:

1. Create the Macro normally in the Macros tab.

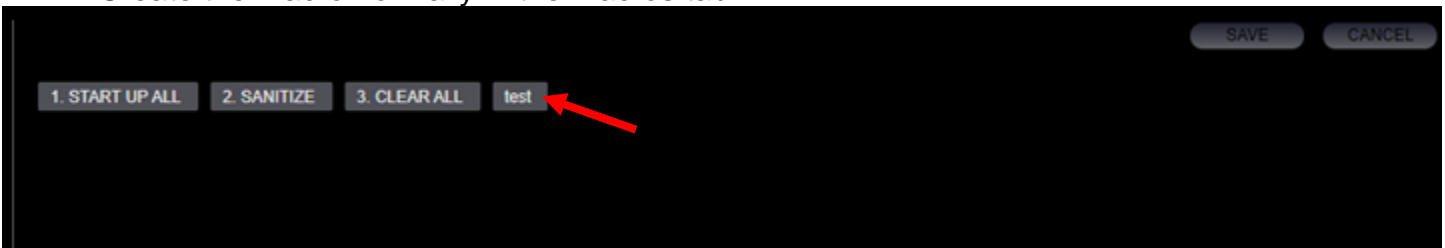

2. Add the new Macro to a Tag.
3. It will then appear in the Macro frame of the Drag & Drop page.

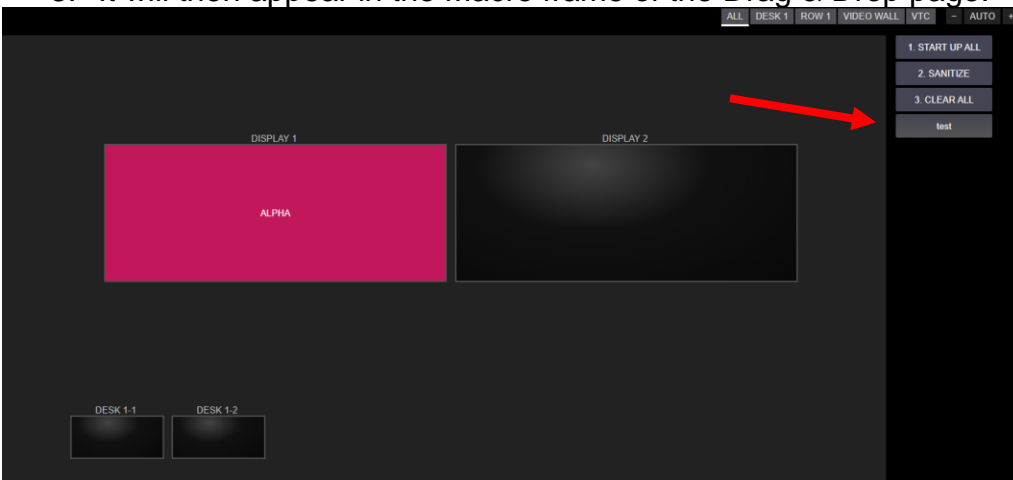

To add the Macro to the Destinations frame, add the prefix “MACRO_” and the X, Y, W, H parameters. You can also specify an Alias and a color here.

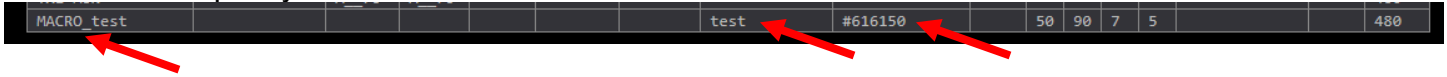

It will now appear in the Destination frame.

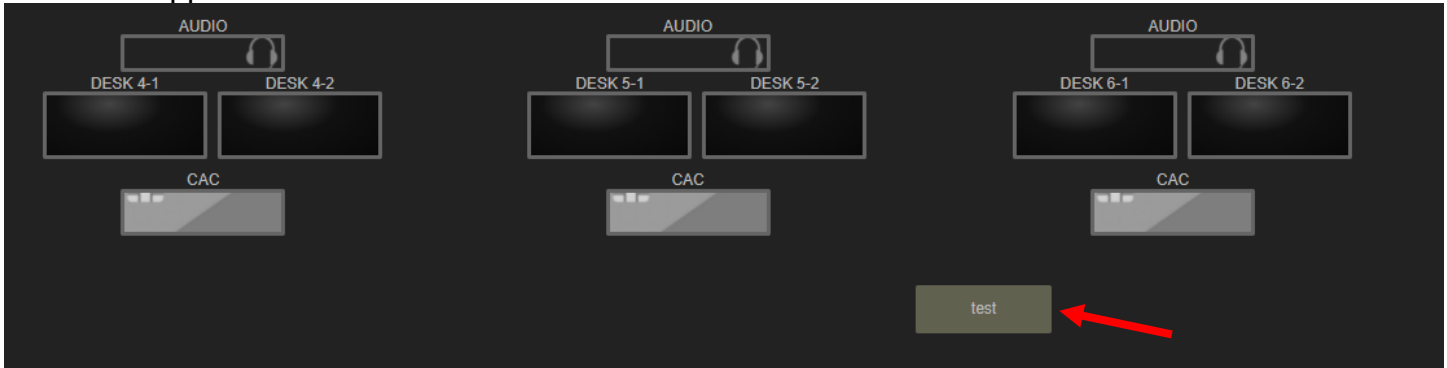

While configuring this feature, it may be necessary to refresh the browser page (F5) to see the change. To delete a Macro that has been moved to the Destination frame; **first** delete it from the Destination Frame, **then** delete it from the MACRO tab.



Note: When initially created the Macros may not function. For security purposes, the Users that will be accessing the Macro need to have permission for the assets contained **within the Macro**. This applies to Users logging in, Keyboard Users calling an OSD, or Touchpanels that are displaying Macros. (You may need to add Keyboard users for this purpose.)

□ The OVERLAY Tab

The **OVERLAY** Tab is used to format text that will show over the monitors video image. Left-click in the TX or RX field to select from a drop-down menu as shown below.

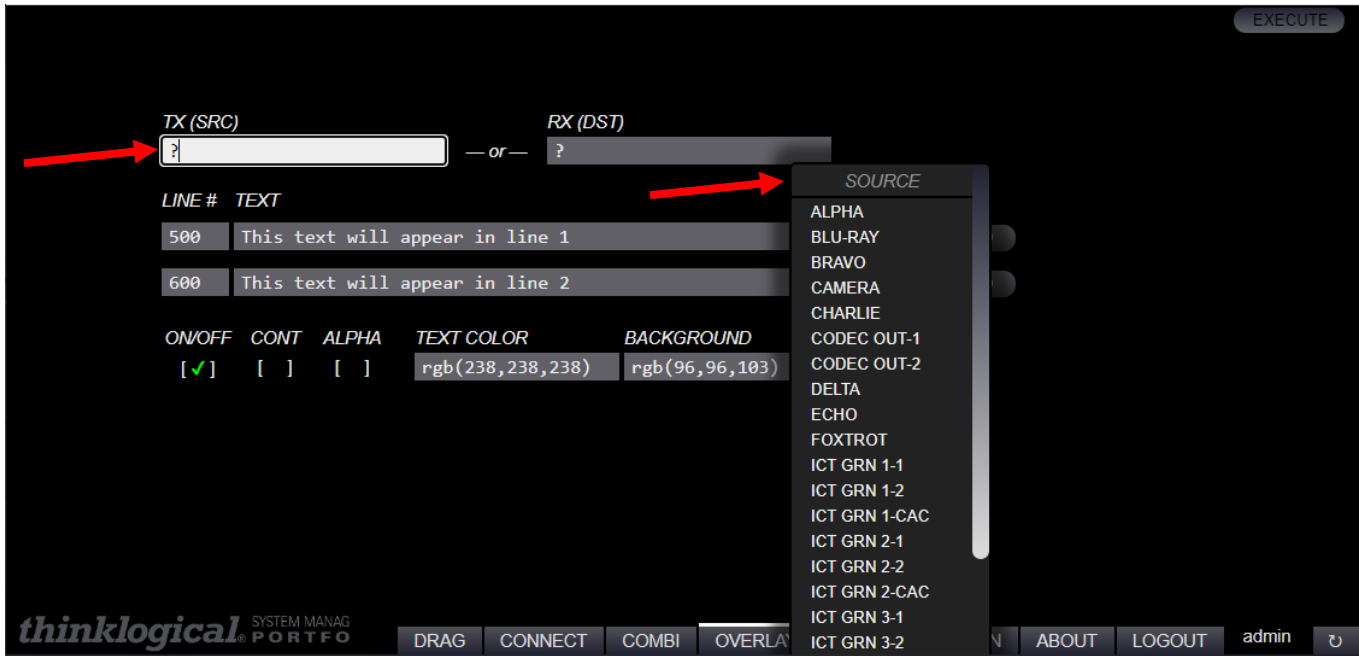

Click on the **ABOUT** Tab for more information about the various fields. **LINE #** is used to position the Overlay on the screen. The value is the number of pixels down from the top.

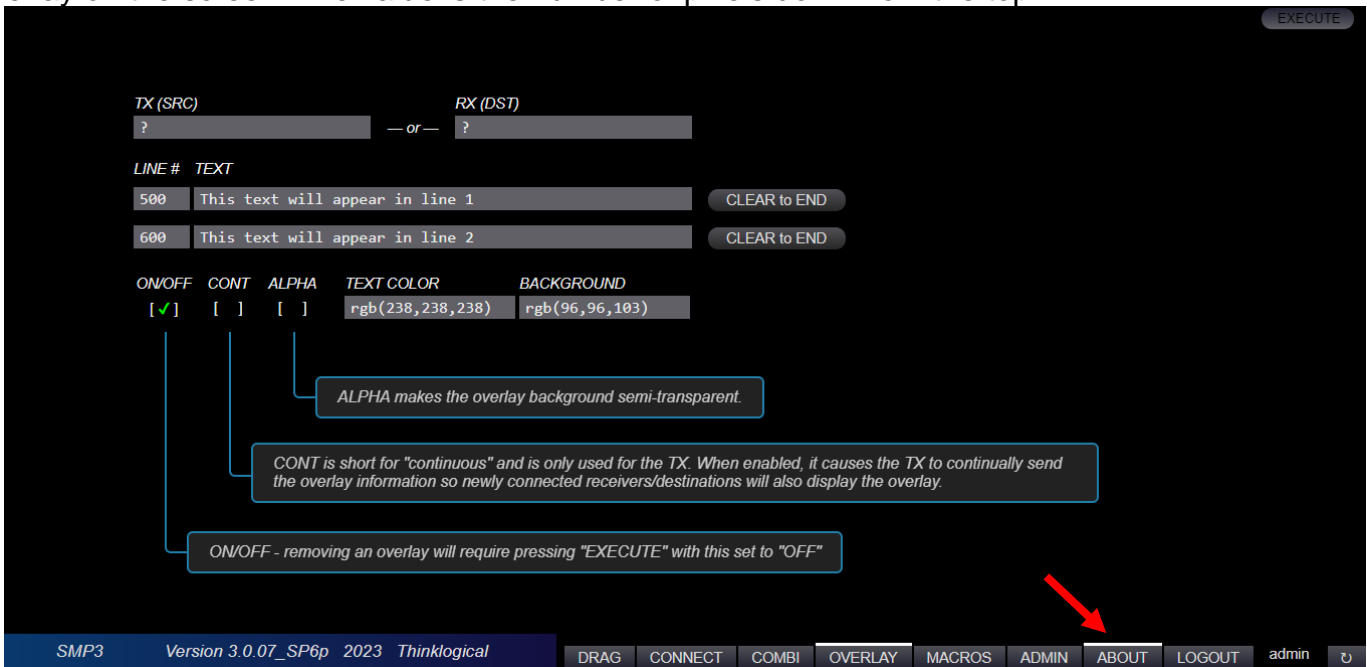

Note: The OVERLAY feature is not available on the SMP Module as it does not have monitoring ports.

Choose from a range of colors for both the overlay text and overlay background by left-clicking on the TEXT COLOR and BACKGROUND fields.

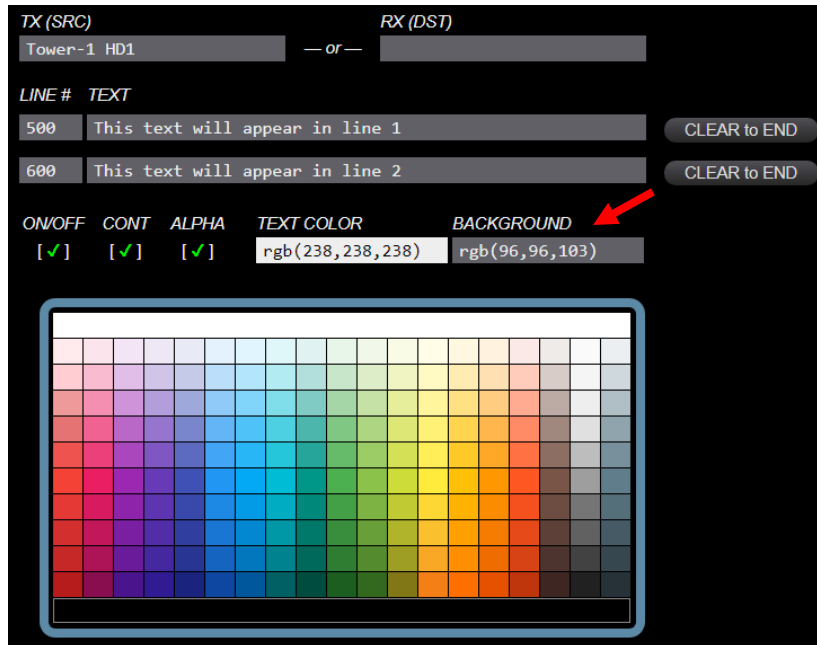

Other prerequisites for Overlay.

- Column name needs to be “Vid(R)” in SRCS.
- Column name needs to be “Vid(T)” in DSTS.
- Columns Kbd(R) and Kbs(T) need to be in DSTS.

Src Name	Follows	Vid(R)
----------	---------	--------

Dst Name	Follows	Vid(T)	Bck(R)	Aud(T)	Kbd(R)	Kbs(T)
----------	---------	--------	--------	--------	--------	--------

- The monitor ports MUST be named “RX MON1” and “TX MON1”.

□ The COMBI Tab

The COMBI Tab is functionally identical to the CONNECT Tab but is formatted to accommodate use on a Touchpanel Screen or OSD configured for it. See THE CONNECT TAB, below, for an explanation of functionality.



□ The CONNECT Tab

The **CONNECT** Tab's Graphical User Interface makes it easy for administrators to see connections on-screen and switch Sources and Rooms with a few mouse clicks.

A sample **CONNECT** page is illustrated below. In this example, Source ALPHA is connected to DESK 1-1 with KM control (note the mouse icon).

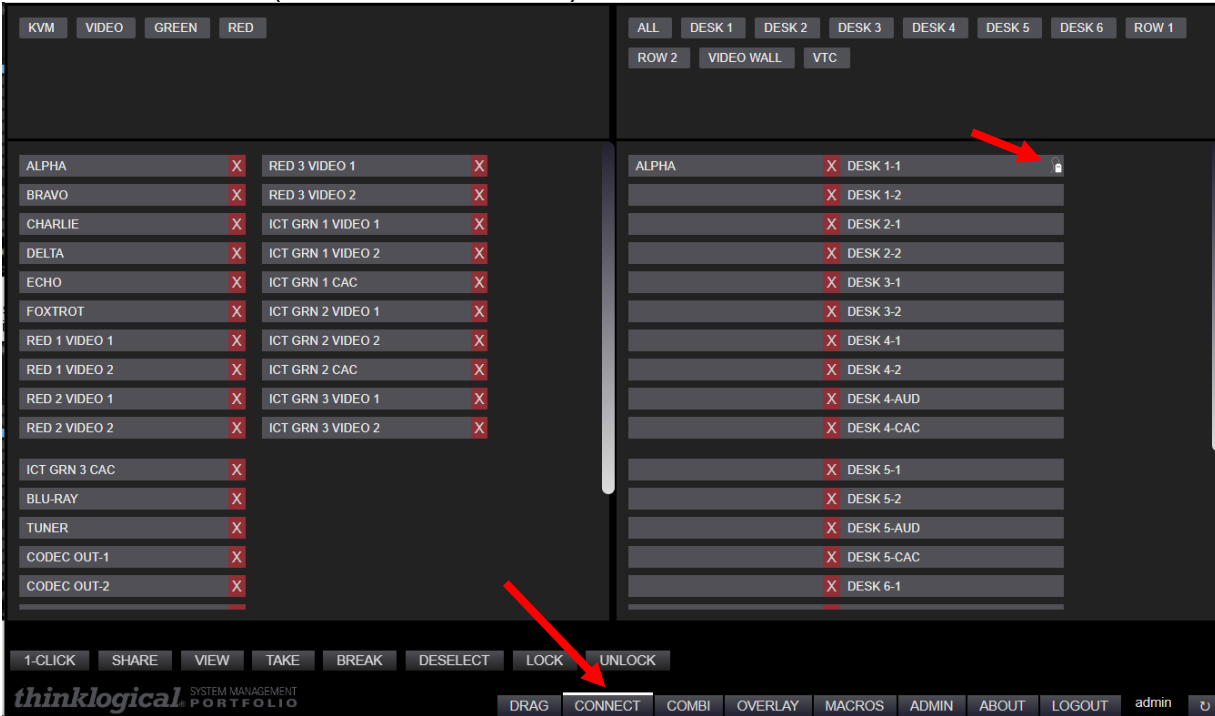

A typical operation will select a Source from the left and a Destination from the right. The selected assets will then be highlighted in blue.

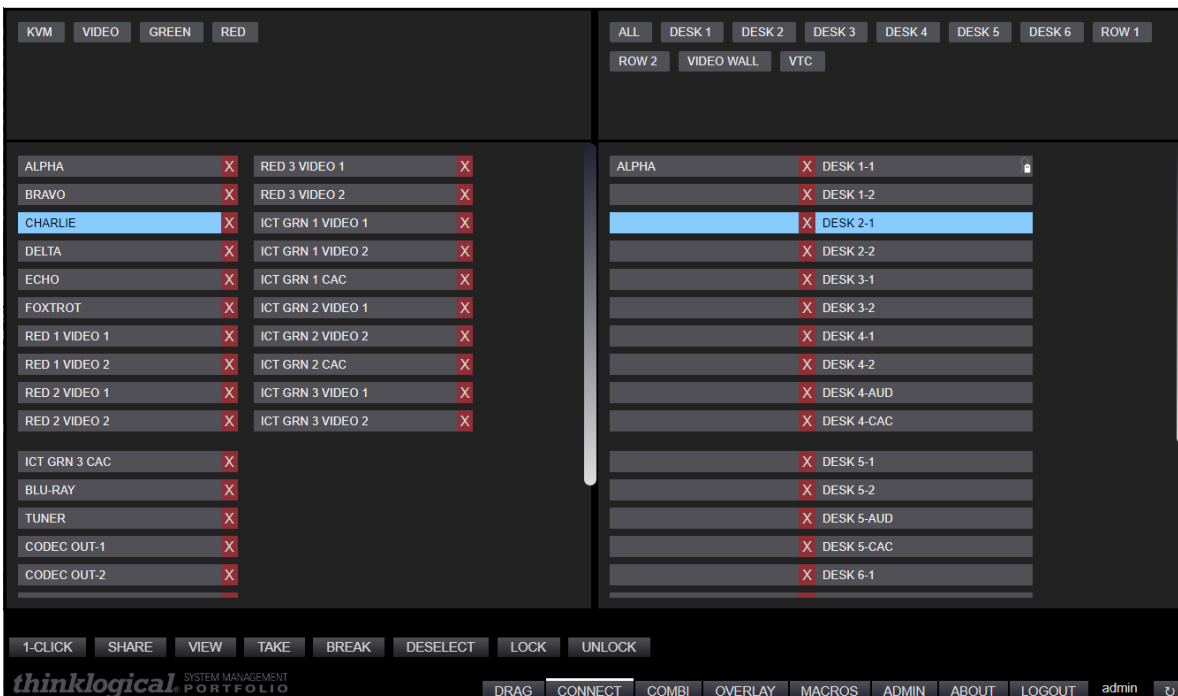

By clicking the TAKE button, Source CHARLIE will be switched to DESK 2-1 with KM control. If the VIEW button was used then only the video would be connected.

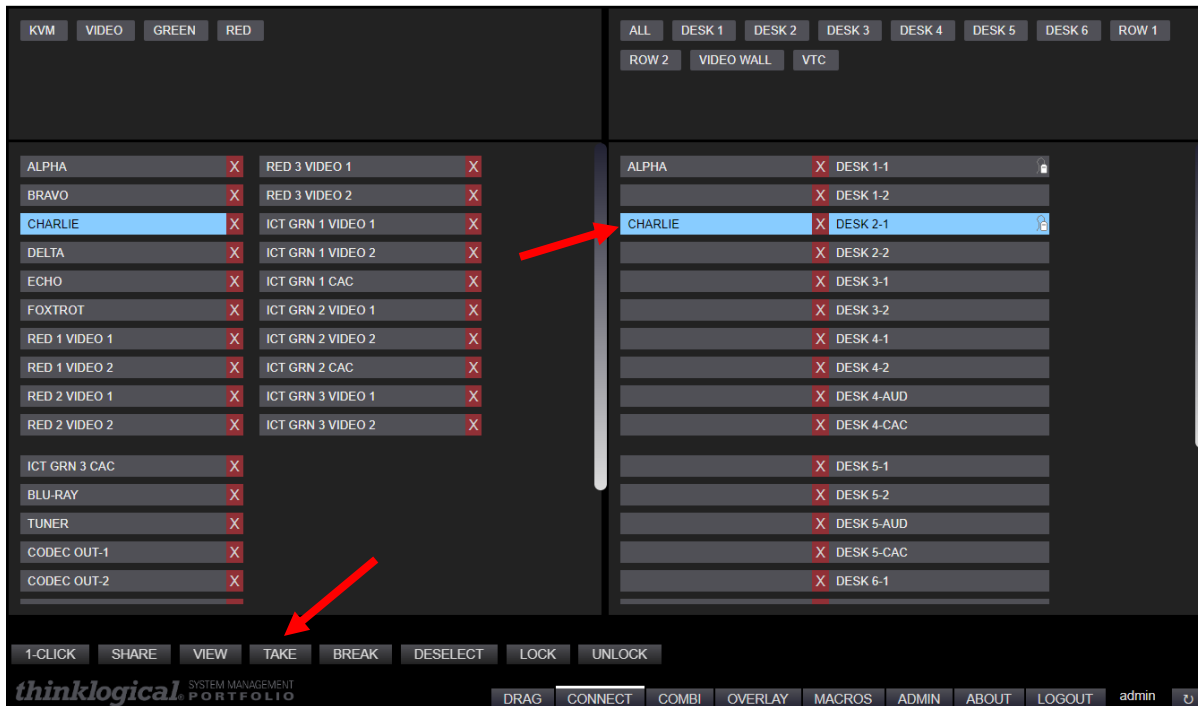

Destinations with active sources will show the names of those sources on the left side. Hovering the cursor over a source or destination will highlight in orange any connections involving that source or destination. Clicking on **X** will break that connection.



A set of tabs along the bottom, left portion of the page (below) gives users a variety of ways to make and break single or multiple video and data connections.



- **1-CLICK:** Click on any Source and any Destination to make a connection. **Must be used in conjunction with the other tabs**, listed below. (If 1-CLICK and either SHARE, VIEW, TAKE, or BREAK are selected, as shown above, then the selected action (SHARE, VIEW, TAKE, or BREAK) will be executed immediately.)
- **SHARE:** By default, when additional Destinations are connected to a previously connected Source, they will all share the video from the Source, but only the last one connected will have control of the mouse, or data return (as shown by the mouse icon).
- **VIEW:** Each newly connected Destination can view the video but will not take the data return.
- **TAKE:** Each newly connected Destination removes the video from all previous Destinations and the new Destination will take the data return.
- **BREAK:** Will break the connections of any highlighted Sources or Destinations.
- **DESELECT:** Clears all highlighted selections at once.
- **LOCK:** Locking a Source prevents it from being routed. Locking a Destination prevents it from being Cleared or routed over. A dashed line around the border will indicate a Locked condition.
- **UNLOCK:** Removes a Lock condition.

Connections can also be divided into **Tags** that appear in the tabs along the top. As shown in the example below, when the **GREEN** Tag is selected on the Source side, it will turn blue and only destinations that are members of Tag GREEN are displayed. Similarly, for the Destination side as illustrated with the **DESK 1** tag. This feature is most useful at larger sites with many Sources and Destinations. See the separate **TAGS** section for configuration.



□ The DRAG (Drag & Drop) Tab

The Drag & Drop Graphical User Interface makes it easy for users to visualize their workstations on-screen and switch Sources and Destinations by simply moving an icon. **As room configurations evolve over time, icons representing Sources and Destinations can be added or removed from the layout as required**, making it simple to adapt to changing requirements.

Click on the **DRAG** Tab. The Sources, Pools, Tags, Macros and Destinations in the demonstration example are graphically depicted below in the Drag & Drop GUI.

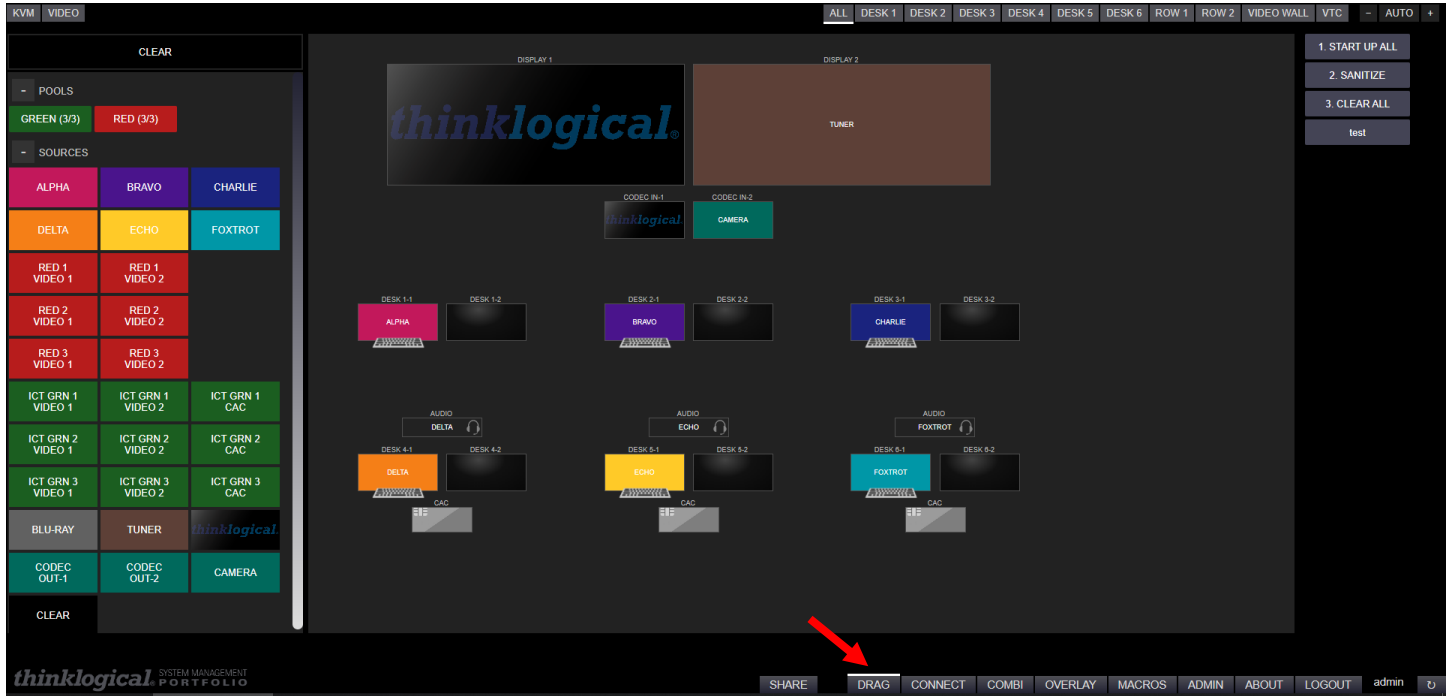

Connections are made by dragging a SOURCE icon from the POOL or SOURCE frame (or from another Destination) to a desired Destination. The Keyboard icon indicates which Destination has control of the keyboard and mouse. In this example, DESK 3-1 has control of the keyboard for Source CHARLIE.

To **CLEAR** a Source or Destination: 1) Drag the CLEAR icon, 2) Drag a blank Destination monitor, or 3) Right click on an icon and select CLEAR (see below).

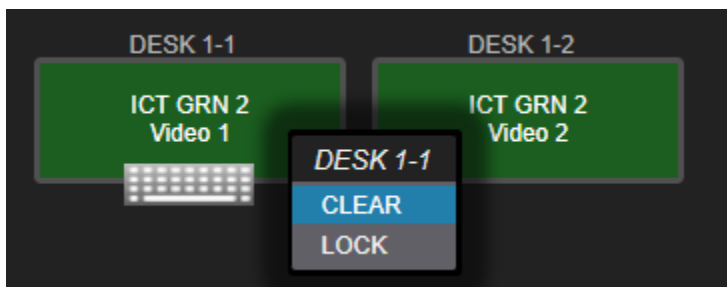

Tags are displayed along the top of the Drag & Drop page with Source Tags on the left and Destination Tags on the right. Selecting one of these Tags will display the assets of that Tag and will automatically zoom for the best fit. This is especially useful in larger sites with many Sources and Destinations. There are also separate “+ AUTO –” buttons for general zoom functions. These buttons are active in the full Destination list view. See also TAGS section.

Example – DESK 2 Tag selected:

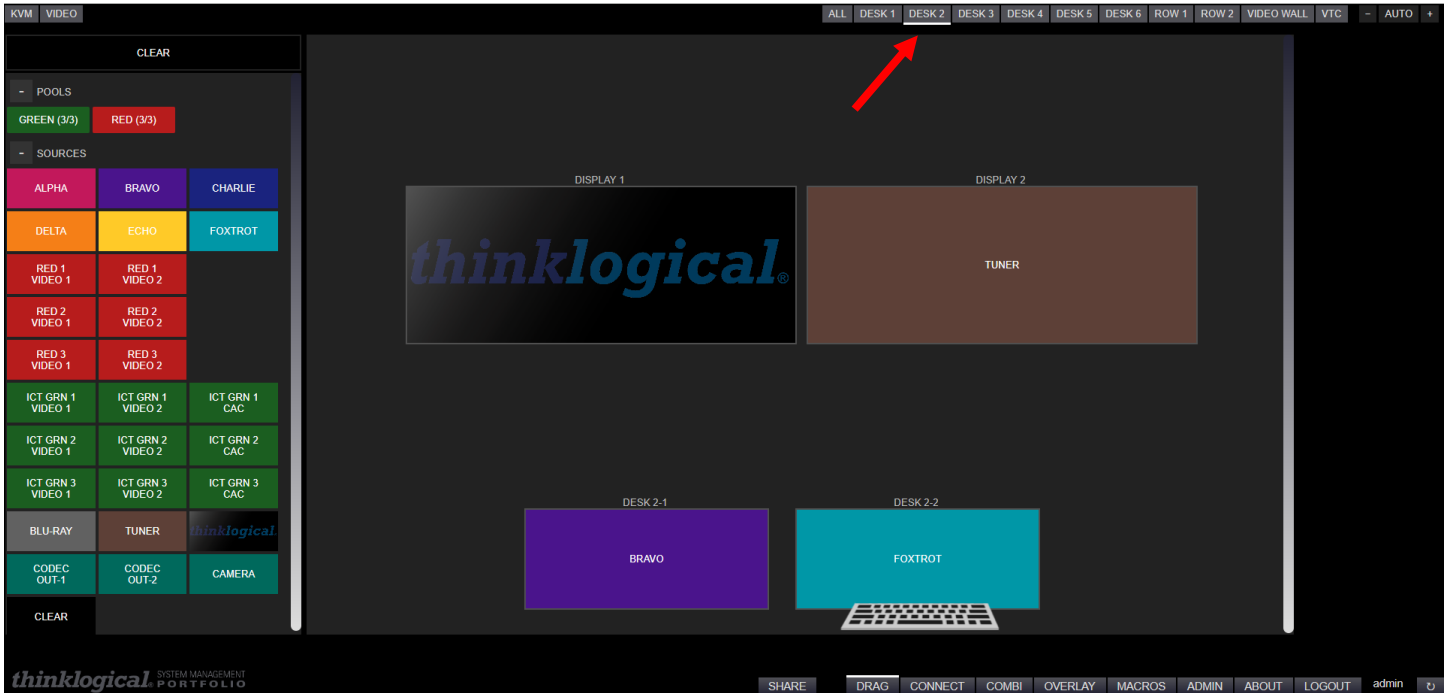

Example – ROW 2 Tag selected:



Using POOLS

Users can reserve Sources from any number of Pools, each of which can have its own function. Pools can be used with OSDs, Touchpanels and Drag & Drop. Once a User has Reserved a Pool, they can then select a Pool Source for use.

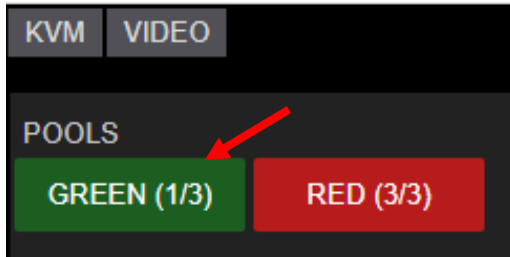

Example: Pools have been created and available (none are currently Reserved here). Note that the POOL icon takes the color of the first Source in the POOL for convenience.

Note also in this example the (1/3) indication. This shows there is one Source left (available) out of a total of three.

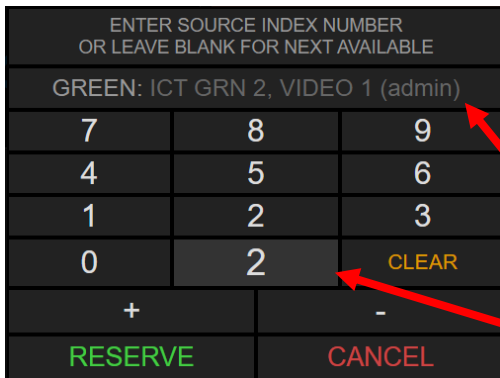

Click GREEN for example and a popup will allow you to choose a Pooled Source if desired.

Click on **RESERVE** for the next available Source.

Click on + / - to scroll up and down the Sources. A Pooled Source in use will be grayed out and show which User has that Source. The Pooled Source number will appear below the 2 and the name will appear at the top.

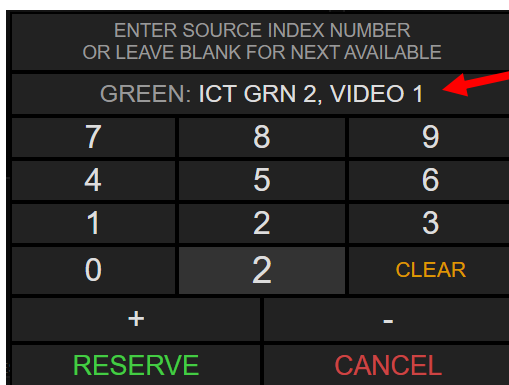

In this example the Pooled Source #2 named "ICT GRN 2, VIDEO1" is selected.



Note: The number indicated is related to what is configured in the SRCS Primary column. In this example "ICT GRN 2, VIDEO1" is the second Primary column value listed.

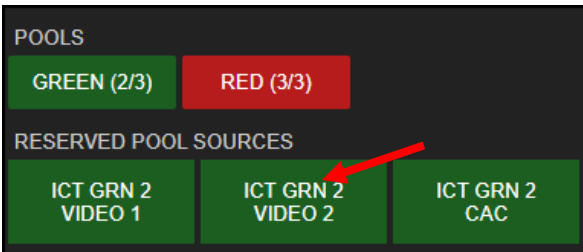

Click **RESERVE** and that GREEN Pool Source is reserved and “RESERVED POOL SOURCES” is added to the Source frame.

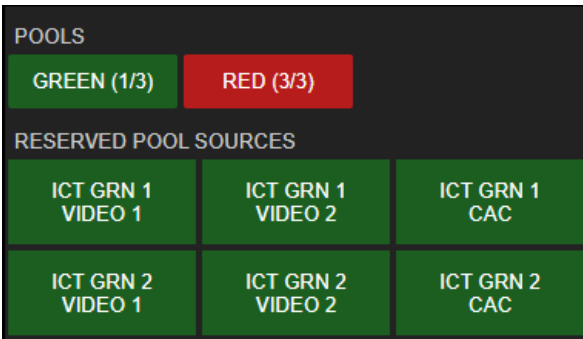

This process may be repeated to Reserve multiple sources.

Once a Source is Reserved, the User can then connect it to their desk.

Note that Reserved Sources cannot be Reserved or accessed by another User. Exception: See Publish below.

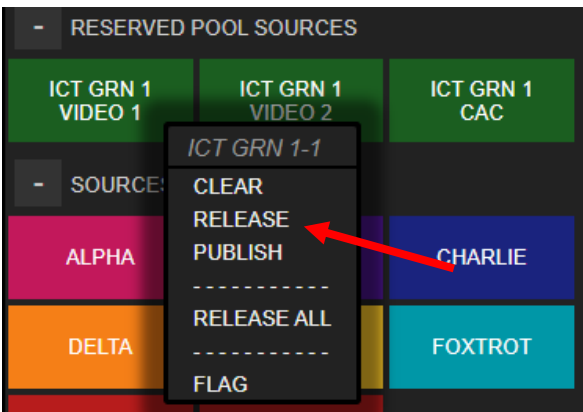

To release a Source back into the Pool, right click on the Source and choose **RELEASE**.

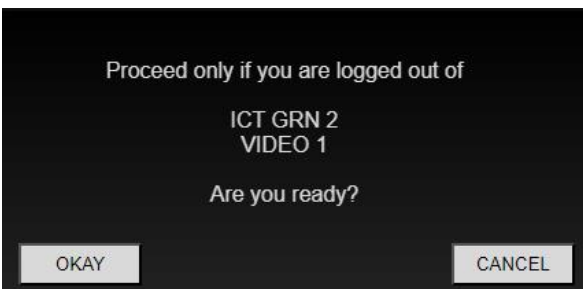

A warning message will pop up.

Other options from this menu are:

- Clear – This option clears the Destination connected to this Source.
- Publish – Allows a Source to be viewed by Users that do not have the POOL Source Reserved.
- Flag – This alerts that this Source is having a problem. The System Administrator can then address the issue.



Note: When publishing a Source only the video is available (view mode). Also, only video Sources may be Published. For example: a CAC Source cannot be Published since there is no video component. Choosing Publish will create a new category showing PUBLISHED POOL SOURCES. The Source will also show a dashed line around the icon. This Published POOL Source will then be available to all Users to view. This new category will also appear on OSDs and Touchpanels.

Right click on the Reserved Source to publish it. The Source icon border will change to indicate it is Published.

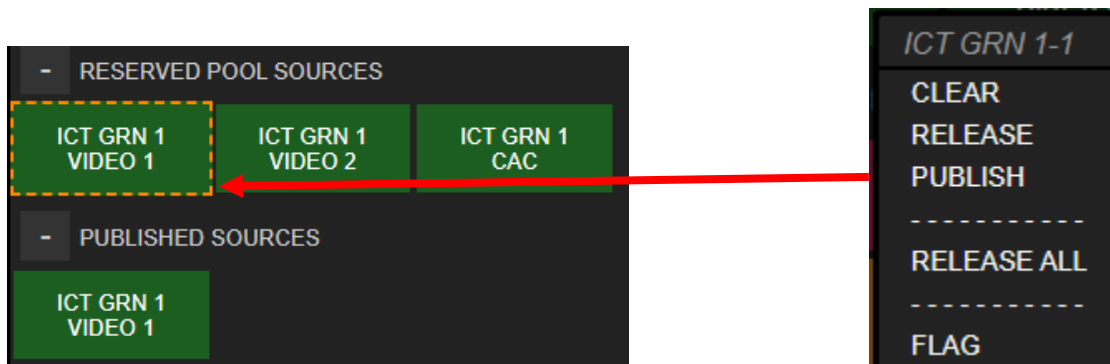

Right click on the Published Source to unpublish it.

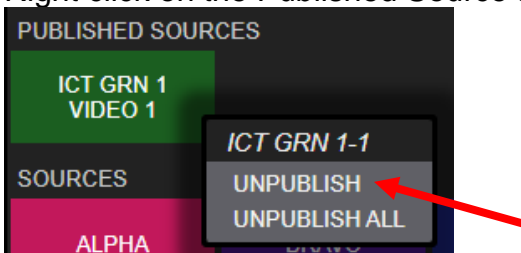

There are other functions available on the Drag & Drop page utilizing the right mouse button.

- Right Clicking on a **Destination** and selecting CLEAR will clear that one Destination.
Example: DESK 1-2.
- Right Clicking on a **Destination** and selecting LOCK will not allow another Source to be routed there.
Example: DESK 1-2.
- Right Clicking on a **Source** and selecting CLEAR will clear that Source from all Destinations.
Example: ALPHA.
- Right Clicking on a **Source** and selecting LOCK will not allow that Source to be connected to any new Destinations. Example: ALPHA.
- Right Clicking on a **Source** and selecting PUBLISH will allow another User to connect and view this Source.
- Right Clicking on a **Source** and selecting FLAG will indicate to the Admin this Source may be faulty. The User will be prompted for confirmation.
- Right Clicking on a **Pool Source** and selecting RELEASE will release a Pooled Source that has been Reserved.
Example: RED 1-1

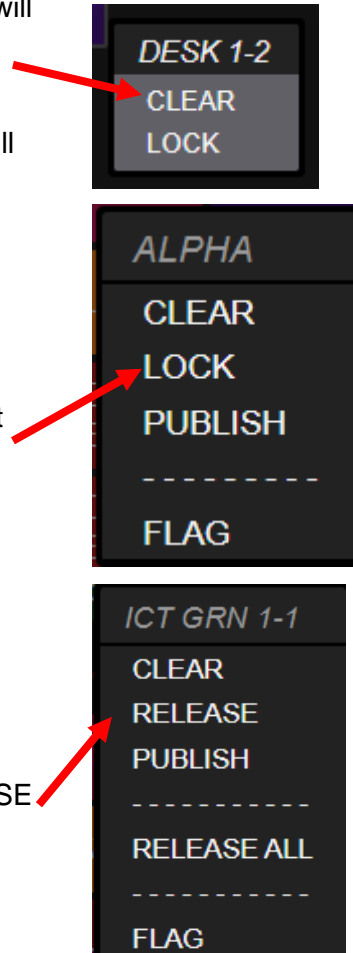

Note: When using a Touchpanel, the right mouse button functions may also be used. Press on a Touchpanel location for >2 seconds (“long press”) for this feature.

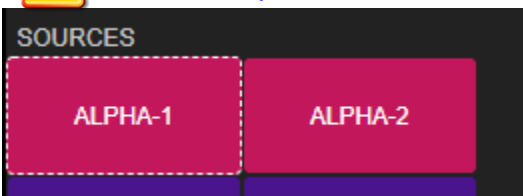

Locked Sources will appear to Users with a dashed line border.

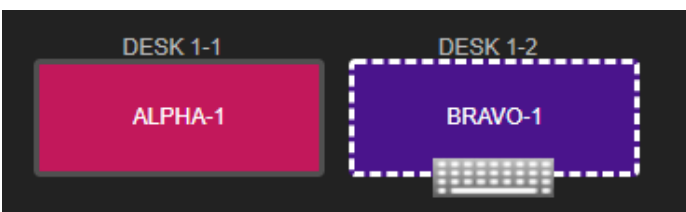

Locked Destinations will also appear to Users with a dashed line border.



Warning! Locked Sources and Destinations can only be unlocked by 1) The User that Locked them or 2) The Administrator.

TECH NOTES: *Customize Drag & Drop*

The appearance of the Drag & Drop page can be further customized:

1. Text in the **Alias** column can be centered by preceding it with (c), right justified with (r), or left justified with (l). You may also have multiple lines within an icon by entering
 between text strings. If you wish to have no label in the Destination icon, then enter (blank) in the Alias column.
2. Custom images may also be used, but sizing is important. The system will take a custom image and size it to match the width of the icon. If the aspect ratios are the same, then this will appear correctly. But if they are not, this may result in clipping of the image, so take care when creating custom images for use in Drag & Drop. One technique is to add extra border area to the image, where appropriate, to 'fine tune' it to size.
3. Drag & Drop icon Images are located in /opt/t1/smp2/public/images.
4. Icons in the Sources Frame can be arranged for clarity. For example, to have 2-headed Sources line up properly with 3-headed Sources. This is done by adding a line to the Sources tab to create a blank space there. This line will have no ports assigned and the Alias set to "(blank)".

Example:

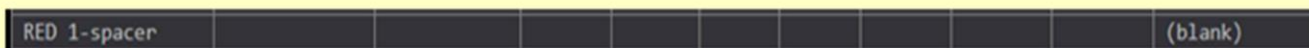

Sample Images

You may wish to download the /opt/tl/smp2/public/images directory to a PC for review. Examples:

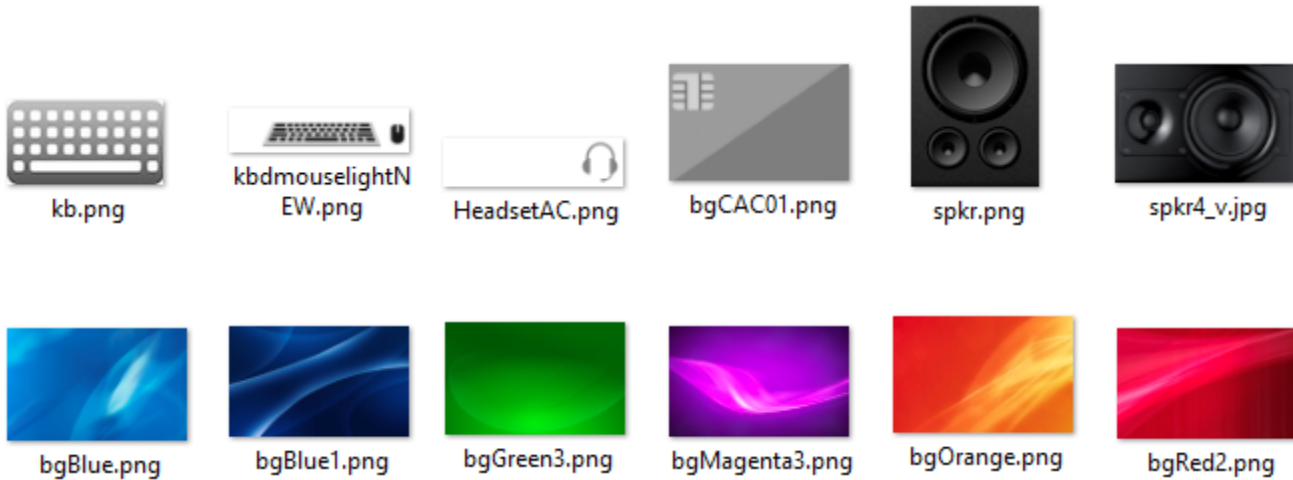

TECH NOTES: *Adjusting the appearance of Touchpanel Drag & Drop*

When using the Touchpanel in Drag & Drop mode, some adjustment in the configuration may be necessary to get the icons to display the way you wish. One parameter you can change is the Frame size (Source, Destination or Macro Frames). Within the Frame we need to remember that the Source and Destination icon sizes are in percentage of the Frame that they are located in. So for example: If our Sources are all 33% they will display three to a row. However, if there are a lot of Sources and a scroll bar is created (which adds 3%) then the total will be 102%. The icons will then display two to a row. To correct this one option is to change the Source width to 30% and they will then display three to a row again.

□ The SHARE button

Clicking on the SHARE button will allow the Drag and Drop behavior to be modified.

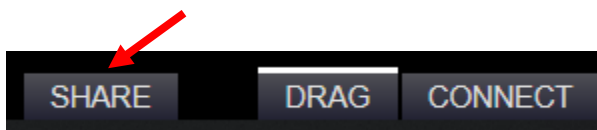

SHARE – When a Source is dragged to another Destination, keyboard control goes to the new Destination and the video stays at the old Destination.

VIEW – Drags only the video to the new Destination, video stays at the old Destination.

TAKE – Video and keyboard control go to the new Destination, both are removed from the old Destination.

□ The Refresh Button

There is also a Refresh button on the bottom of the browser page.



This is equivalent to hitting F5 on a keyboard to refresh the browser. The page will then reload. This is necessary to view certain configuration changes that are made that affect the browser; such as Drag & Drop appearance, etc.

Additional Touchpanel Notes:

- SMP3 supports the POE Touchpanel only, P/N TPL-7 and TPL-10. The older models, VXM-000011 and VXM-000016 are not supported.
- The Touchpanel name (as configured in the Users tab) is displayed in the lower right corner.
- Source Tags can be created to filter Source names for convenience. These Tags will appear in the upper left corner of the Touchpanel.
- If there are many Sources, the user may “swipe” up and down to access the desired Source if not visible.
- Touchpanels use the Firefox browser for multi-touch support.

Configuration Backup

After completing the SMP3 configuration, Thinklogical recommends creating a backup using one of the following methods:

1. The **IMPORT** and **EXPORT** functions provide a fast and convenient means to save and reload the SMP3 configuration files. This facilitates offline editing and restoration of archived configurations and is a convenient way to save work as the system is being built. It is then relatively easy to 'go back one version' if an error is made.

Selecting EXPORT will save the appropriate file to the directory `/home/user/Downloads`

These functions are context sensitive. For example, the `stations.csv` file is exported when in either the SRCS, DSTS, KBDS, FRMS or MTX Tabs and contains all the information within those tabs.

The tabs HOTKEYS, TIE LINES, USERS, TAGS and POOLS will export their corresponding files.

Files that can be exported and imported are:

- `stations.csv`
- `hotkeys.csv`
- `tielines.csv`
- `users.csv`
- `tags.csv`
- `allocations.csv`

If MACROS are created, they cannot be archived using the IMPORT and EXPORT functions. These macros are located separately in the `/opt/tl/setup/macros` directory and a backup must be copied from there.

2. Create a backup of your **entire** configuration:

For example: Issue the following command from any directory (for example):

```
tar -cvzPf customer_20220718.tgz /opt/tl/setup
```

This will create a backup file of the entire setup directory with your name (`customer`) and date (`20190718`). This is also the preferred method for creating a backup to archive your configuration in a location separate from the SMP3 itself for safekeeping.

See also Appendix K

The SMP ADM

Introduction

The Thinklogical ADM is a web-based administrative interface utilized on the following Thinklogical systems: TLX Matrices, SMP systems. ADM efficiently enables both secure deployment and secure maintenance for the aforementioned Thinklogical systems. ADM is intended to provide both a significant reduction in the secure deployment effort and significant enhancements to the operations and maintenance of Thinklogical solutions.

ADM Features

The prominent features of ADM are:

Key operation and management features:

- User account management (web servers and Linux OS).
- IP addressing configuration.
- System redundancy configuration / monitoring.
- Troubleshooting / status reporting.
- DATE/TIME services.
- Server upgrade support.

Key secure deployment features:

- Firewall configuration.
- FIPS 140 (encryption) compliance.
- Password complexity enforcement.
- Remote logging, auditing.
- Secure network topology guidance.
- Supports full network encryption.
 - Web-based services utilizes https (FIPS 140 compliant encryption).
 - SMP to/from Matrix comms utilizes MACsec (AES-GCM-256, TS compliant).



Warning! The secure deployment features should be configured by experienced Administrators. Improper configuration may result in the Matrix Switch being inaccessible.

Setup

Pictured below is a typical system.

⚠ Note: The **default** IP address of the SMP/ICT and SMP Module ETH0 is 192.168.13.9 and for the SMP Appliance ETH0 is 192.169.74.207, ETH1 is 192.168.13.9. Therefore, your browsing device (such as a laptop) must be configured for the proper ETH0 subnet.

Note: Prior to MACsec support, most SMP Appliance installations used ETH1 for Matrix Switch communication. However, MACsec operates on ETH0 only so your cabling and IP configuration may require changing.

See also the Quick Start Guide in Appendix A.

Connection Diagram

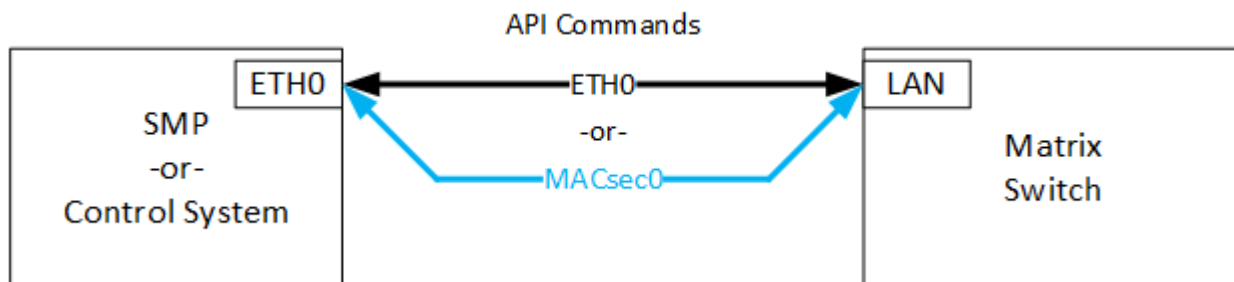
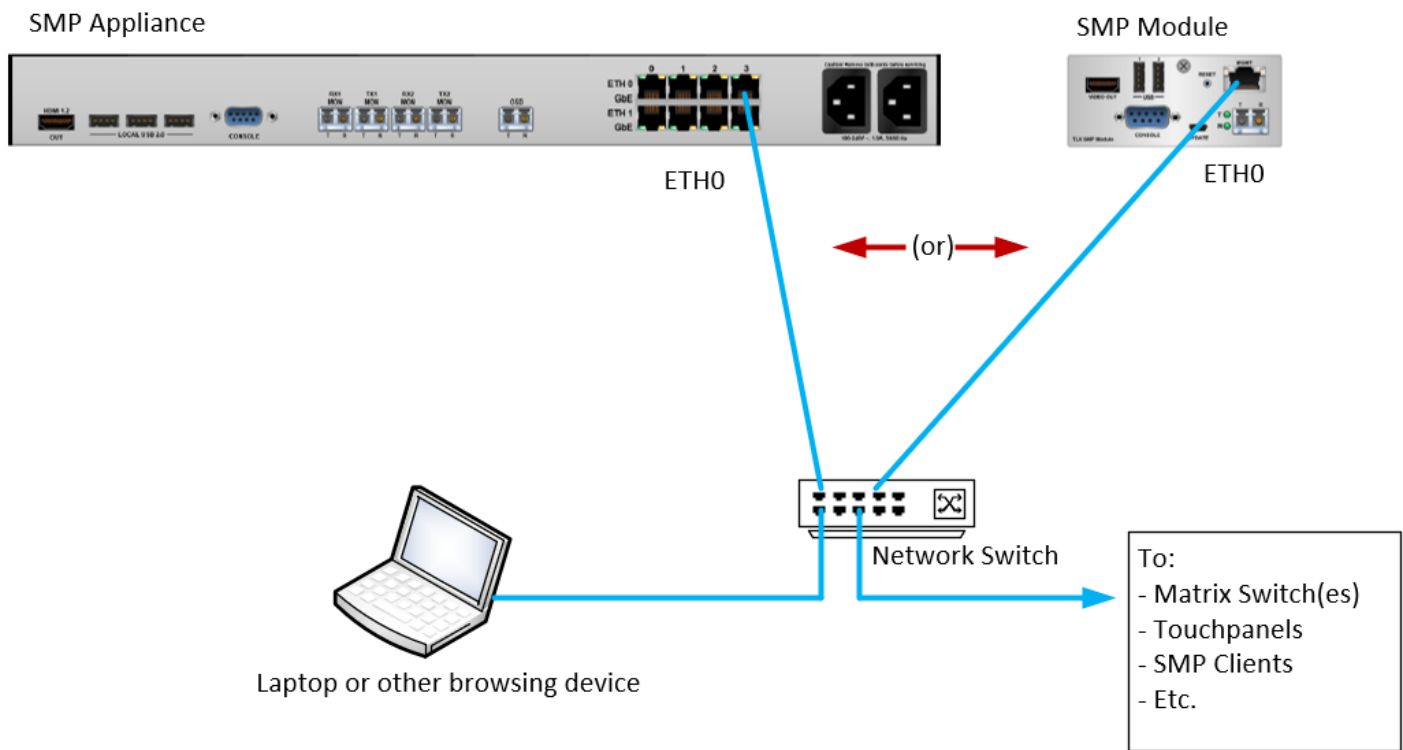

⚠ Note: The API commands travel on the same physical interfaces when using eth0 or MACsec0 network devices.

Using ADM

Logging in

Browse to the ETH0 default address, port 60087:

- SMP Module or SMP/ICT - <https://192.168.13.9:60087>
- SMP Appliance - <https://192.168.74.207:60087>



Note: You may view the SMP Appliance ETH0 IP Address from the Front Panel.

You will then see the login page; **default** credentials are [admin / admin](#).

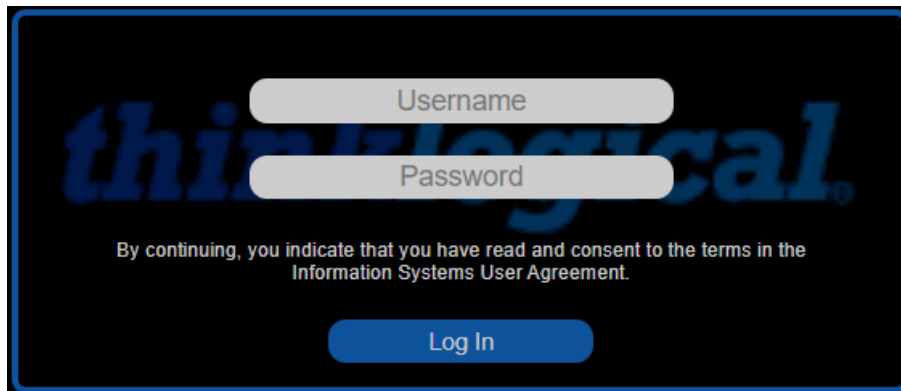

Note: After logging in you will notice a Page Refresh icon at the bottom of each page. Pressing Refresh will require a new login.



□ The NETWORK Tab

□ The HOSTNAME Tab

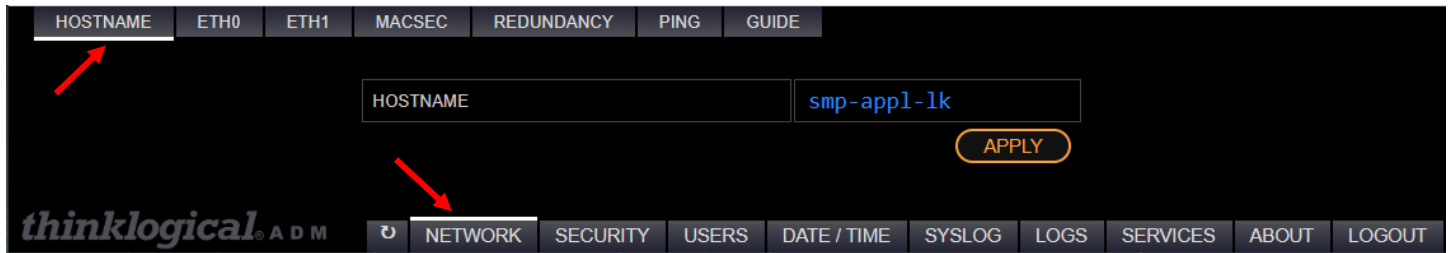

HOSTNAME - Defines the name of the Linux machine. Hostname is mapped to an IP address via “hosts” file or a Domain Name System (DNS) server.

[APPLY] - Modifies the /etc/hostname file.

□ The ETH0 Tab

This is the first SMP external ethernet interface.

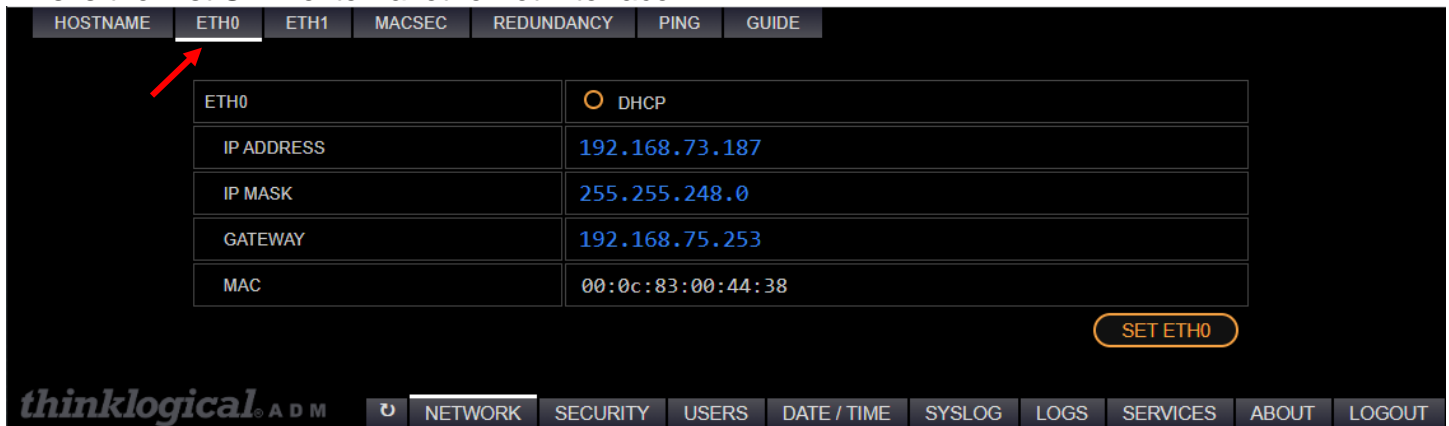

[DHCP] – Enables SMP to obtain IP address, mask and gateway from a “Dynamic Host Configuration Protocol” server.

IP ADDRESS – The physical IP address of ETH0.

IP MASK – Utilized to define the size of the subnetwork (range of consecutive IP addresses).

GATEWAY – Forwarding host IP address (access point to another subnetwork).

MAC – Unique identifier assigned to a network interface, not changeable (Thinklogical = 00:0c:83:xx:xx:xx).

[SET ETH0] – Configures network interface with configurable entries.

□ The ETH1 Tab

This is the second SMP external ethernet interface (SMP Appliance only).

HOSTNAME	ETH0	ETH1	MACSEC	REDUNDANCY	PING	GUIDE
ETH1		<input type="radio"/> DHCP				
IP ADDRESS		192.168.13.9				
IP MASK		255.255.255.0				
GATEWAY						

[SET ETH1](#)

thinklogical ADM | NETWORK | SECURITY | USERS | DATE / TIME | SYSLOG | LOGS | SERVICES | ABOUT | LOGOUT



Warning! The ethernet ports on eth0 and eth1 are *separate, 4-port, network switches*. As such they cannot be configured for IP addresses on the same subnet or within the same address range defined by the netmask.

□ The MACSEC Tab

MACsec = Message Authentication Code security (not MAC address).

MACsec (when enabled) is used to encrypt communications between the SMP API and an external Matrix Switch.

HOSTNAME	ETH0	ETH1	MACSEC	REDUNDANCY	PING	GUIDE
MACSEC0		<input checked="" type="radio"/> ENABLE				
ADDRESS		192.168.14.160				
MASK		255.255.255.0				
MKA PRIORITY		255 48 : 80 : 255				
MAC		00:0c:83:00:44:38				
CAK	d056cc0cb80f241f8c34610715fa5b54					
CKN	c6bbc5ac3b2831eb3e935bebf78184a93ba7caef52d19ba0fe6d971f22d95d53					

[CREATE NEW CAK/CKN](#) [CANCEL](#) [SET MACSEC](#)

STATUS

```

cipher_suite=GCM-AES-256
secured=yes key_server_priority=48 active=yes
live_peers=1 potential_peers=0 is_key_server=no

TXSC: 000c830044380001 on SA 0
      0: PN 517135, state on, key 04b7489547c12707161582cf0100000
RXSC: 000c8300d0660001, state on
      0: PN 258726, state on, key 04b7489547c12707161582cf0100000
                    
```

[REFRESH](#)

thinklogical ADM | NETWORK | SECURITY | USERS | DATE / TIME | SYSLOG | LOGS | SERVICES | ABOUT | LOGOUT

MACSEC0 – Layer 2 ethernet cryptographic protocol that relies on GCM-AES-256 to offer network security.

Pre-requisite for MACsec membership:

- Same LAN.
- Support GCM-AES-256 cipher.
- Common CAK / CKN (manually pre-shared).

ENABLE – Enables MACsec using the configured settings.

ADDRESS – Must be part of a unique IP subnet (i.e., not ETH0's IP subnet) dedicated to MACsec membership (32 maximum peers).

MASK – Subnet mask for the MACsec subnet.

MKA PRIORITY – Lowest value determines the Key Server of the MACsec group (a backup controller is the recommended key server). Displayed (in gray) are: Master key server : Backup key server : all others.

MAC – MAC address of the SMP logged into.

CAK – Connectivity Association Key (16 bytes).

CKN – Connectivity Association Key Name (32 bytes), randomly generated keys.

[CREATE NEW CAC/CKN] – Provides random keys to be manually shared.

[CANCEL] – Reverts to prior CAK/CKN random key values.

[SET MACSEC] – Stores parameters: ADDRESS, MASK, MKA PRIORITY, CAK, CKN.

STATUS –

Cipher Suite GCM-AES-256 - Highest security level supported by MACsec.

Live peers – Number of active members in MACsec group.

Key Server – Responsible for generating and distributing the Secure Association Keys (SAKs).

Also Displays other members of the MACsec subnet.

[REFRESH] - Provides current MACsec status.



Note: The configuration on this page applies to the MACsec IP address and the API commands to the Matrices. Normal operation of ETH0 and ETH1 are not affected.



Warning! An SMP Appliance will have two ethernet interfaces; eth0 and eth1. DO NOT configure them for the same IP address, otherwise network issues will occur.

□ The REDUNDANCY Tab

Pertains to Redundant (dual) SMP units operating together in the same system.

Example:

HOSTNAME	ETH0	MACSEC	REDUNDANCY	PING	GUIDE
APPLIANCE	ACTIVE				
REDUNDANCY	● ENABLE				
VIRTUAL IP ADDRESS	192.168.13.9				
VIRTUAL IP DEVICE	ETH0				
SMP SERVER	PRIMARY ● ○ BACKUP				
INTERFACE	ETH0 ● ○ ETH1				
SMP MTX (VIRTUALS) to PING	192.168.13.15				
SMP MTX (BACKUPS) to PING	192.168.13.115				
STATUS : REDUNDANCY	ACTIVE				
STATUS : SMP SERVICE	ACTIVE				
APPLY					
SYNC FROM IP ADDRESS	192.168.13.11				
	SYNC NOW				
SYNC	○ AUTO				
	MINUTES				
APPLY					

thinklogical ADM

NETWORK SECURITY USERS DATE / TIME SYSLOG LOGS SERVICES ABOUT LOGOUT



Warning! This page should *only* be used when setting up redundant (dual) SMP units. Inappropriate settings here may render the SMP temporarily inoperable.

VIRTUAL IP ADDRESS - The address where the active SMP can be reached by Touchpanels, ODSs, and clients.

VIRTUAL IP DEVICE - Valid results are ETH0:1, ETH1:1, NONE.

ETH0:1 - ETH0 redundancy

ETH1:1 - ETH1 redundancy

NONE - redundancy not configured

INTERFACE - Selects which network interface is used to communicate with partner SMP.

SMP MTX (VIRTUALS) to PING - Defined / extracted from the SMP's ADM/MTX tab, utilized for redundancy health check.

SMP MTX (BACKUPS) to PING - Configurable SMP address, utilized for second redundancy health check.

(Note: if either of the aforementioned IP addresses can be successfully PING'd, network connectivity test passes)

STATUS : REDUNDANCY - Status of REDUNDANCY (KEEPALIVED service), states: ACTIVE, STOPPED, or DISABLED.

STATUS : SMP SERVICE - Status of SMP service, states: ACTIVE, STOPPED, or DISABLED.

SYNC FROM IP ADDRESS - The hardware address of the "other" SMP (Backup SMP when configuring Primary, Primary SMP when configuring Backup).

SYNC NOW - Causes immediate copy of configuration from the other SMP, overwrites existing configuration - CAUTION!

AUTO - Enables periodic update from the other SMP (should only be run on the Backup SMP).

MINUTES - Time between periodic updates.



Note: If MACsec is enabled, the VIRTUAL, PRIMARY, and BACKUP addresses should be part of the MACsec LAN group.



Note: See also Appendix F: SMP3 Redundancy.

□ The PING Tab

The screenshot shows the 'PING' configuration page in the thinklogical ADM interface. At the top, there are navigation tabs: HOSTNAME, ETH0, ETH1, MACSEC, REDUNDANCY, PING (selected), and GUIDE. Below the tabs, there is a form with an 'ADDRESS' field containing '192.168.73.54' and a 'PING!' button. Underneath, a 'RESPONSES' section displays the output of a ping command:

```

PING 192.168.73.54 (192.168.73.54) 56(84) bytes of data.
64 bytes from 192.168.73.54: icmp_seq=1 ttl=64 time=0.330 ms
64 bytes from 192.168.73.54: icmp_seq=2 ttl=64 time=0.241 ms
64 bytes from 192.168.73.54: icmp_seq=3 ttl=64 time=0.172 ms
64 bytes from 192.168.73.54: icmp_seq=4 ttl=64 time=0.171 ms
64 bytes from 192.168.73.54: icmp_seq=5 ttl=64 time=0.190 ms
64 bytes from 192.168.73.54: icmp_seq=6 ttl=64 time=0.182 ms
64 bytes from 192.168.73.54: icmp_seq=7 ttl=64 time=0.220 ms
64 bytes from 192.168.73.54: icmp_seq=8 ttl=64 time=0.196 ms
64 bytes from 192.168.73.54: icmp_seq=9 ttl=64 time=0.174 ms
64 bytes from 192.168.73.54: icmp_seq=10 ttl=64 time=0.225 ms

--- 192.168.73.54 ping statistics ---
10 packets transmitted, 10 received, 0% packet loss, time 9004ms
rtt min/avg/max/mdev = 0.171/0.210/0.330/0.046 ms
    
```

At the bottom of the interface, there is a navigation bar with tabs: NETWORK (selected), SECURITY, USERS, DATE / TIME, SYSLOG, LOGS, SERVICES, ABOUT, and LOGOUT.

ADDRESS – Configurable remote IP address to be checked.

[PING!] - Sends 10 data packets to a configurable IP address to test network connectivity.

RESPONSES – Displays success/latency statistics of the IP connectivity of a remote machine.

□ The GUIDE Tab

The screenshot shows the thinklogical ADM interface with the 'GUIDE' tab selected. The interface displays two network topology diagrams: 'Secure Network Topology Example' and 'Standard Network Topology Example'. A red arrow points to the 'GUIDE' tab in the top navigation bar. The diagrams show various network components like switches, servers, and firewalls with their respective IP addresses and configurations.



Note: These are static images of sample configurations and may not reflect your system. Clicking on one will zoom in for clarity.

Secure Network Topology Example

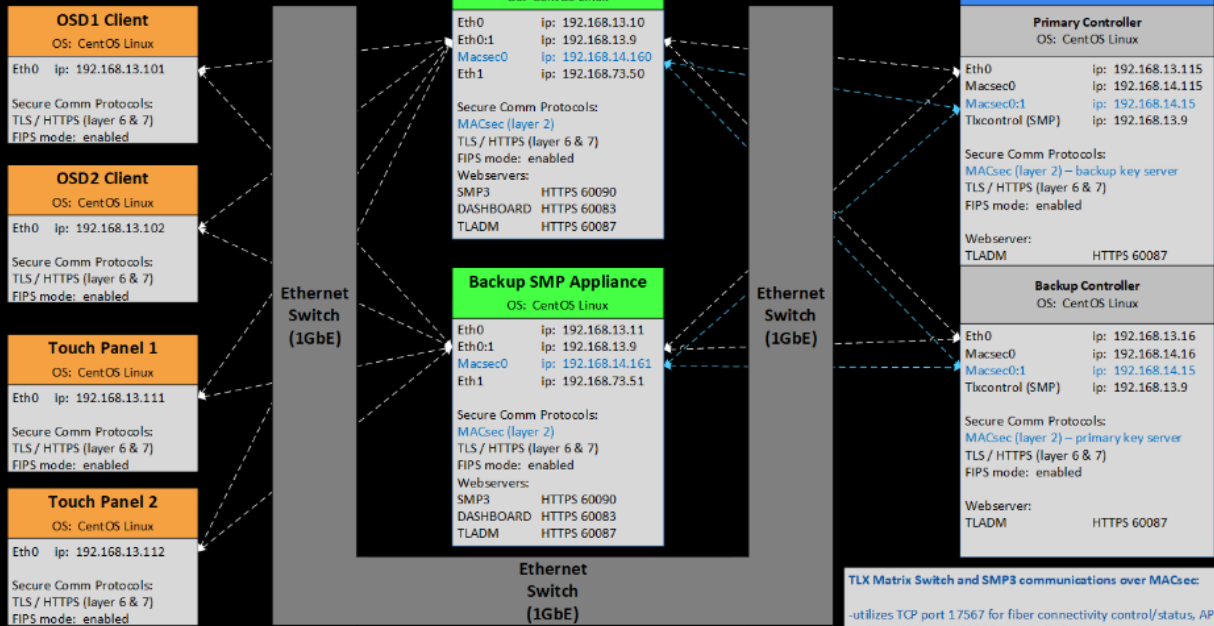

TLX Matrix Switch and SMP3 communications over MACsec:

- utilizes TCP port 17567 for fiber connectivity control/status, API
- utilizes UDP port 17564 for periodic fiber connectivity status
- utilizes UDP port 17560 for OOB / hotkey code events
- utilizes ICMP (ping) for redundancy control / health monitoring

SMP3:

- utilizes VRRP multicast 224.0.0.0 protocol 112, keepalived manages redundancy and virtual network ip address
- utilizes rsync, ssh port 22
- manages synchronization between primary and backup SMP3 servers

NTP Server

Eth0 ip: 192.168.13.xxx
NTP (Network Time Prot.)
- UDP port 123
- TCP port 4460 (secure)

Admin PC

Eth0 ip: 192.168.13.113
Secure Comm Protocols: TLS / HTTPS (layer 6 & 7)
SNMPv3 – UDP port 161,162

Remote Logging

Eth0 ip: 192.168.13.xxx
Remote Syslog
- UDP port 514
- TCP port 6514 (secure)

Notes:

- Wpa_supplicant cipher suite: GCM-AES-256
- MACsec private shared key to be supported manually via TLADM
- SMP pings Matrix over 14 lan (encrypted)
- Matrix pings SMP over 13 lan (not encrypted)

Standard Network Topology Example

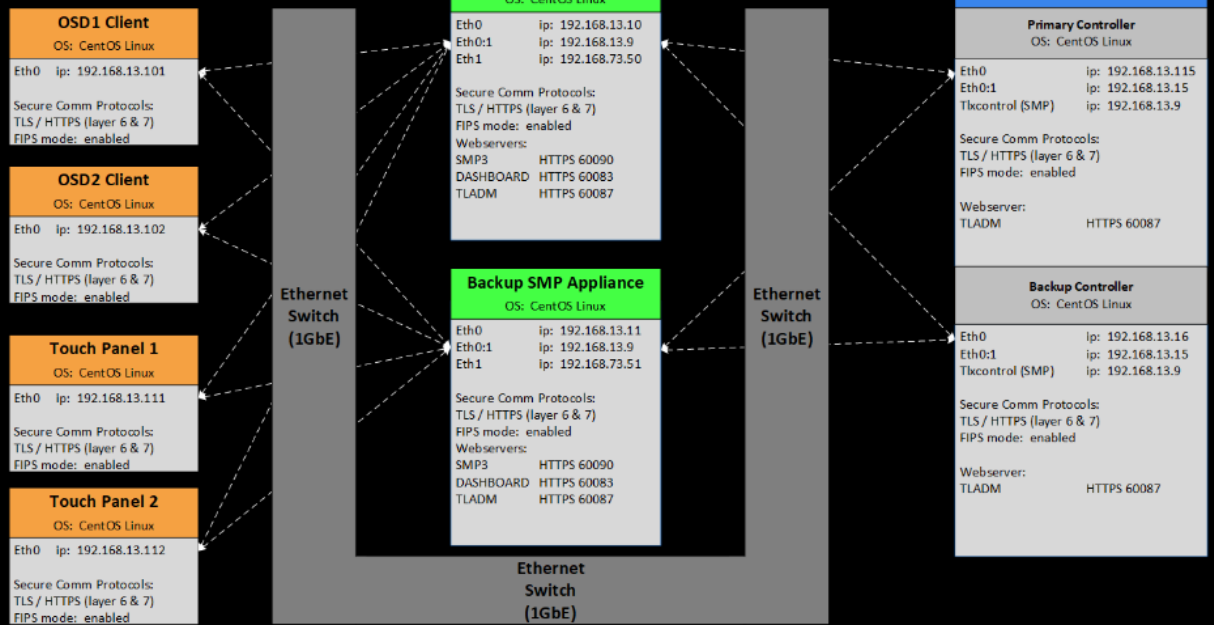

SMP3:

- utilizes VRRP multicast 224.0.0.0 protocol 112, keepalived manages redundancy and virtual network ip address
- utilizes rsync, ssh port 22
- manages synchronization between primary and backup SMP3 servers

NTP Server

Eth0 ip: 192.168.13.xxx
NTP (Network Time Prot.)
- UDP port 123

Admin PC

Eth0 ip: 192.168.13.113
Secure Comm Protocols: TLS / HTTPS (layer 6 & 7)
SNMPv3 – UDP port 161,162

Remote Logging

Eth0 ip: 192.168.13.xxx
Remote Syslog
- UDP port 514

TLX Matrix Switch and SMP3 communications (not encrypted):

- utilizes TCP port 17567 for fiber connectivity control/status, API
- utilizes UDP port 17564 for periodic fiber connectivity status
- utilizes UDP port 17560 for OOB / hotkey code events
- utilizes ICMP (ping) for redundancy control / health monitoring

□ The SECURITY Tab

□ The PASSWORDS Tab

PASSWORDS	
PASSWORD AUTHENTICATION MODULE	<input checked="" type="radio"/> ENABLE
MINIMUM PASSWORD LENGTH	14
MINIMUM LOWER CASE	1
MINIMUM UPPER CASE	1
MINIMUM NUMERIC	1
MINIMUM SPECIAL CHARS	1
MAXIMUM REPEATED CHARS	3
MINIMUM CHANGES NEW / OLD	4
LOGIN FAILURES BEFORE LOCKOUT	3
LOGIN FAILURES INTERVAL (SECONDS)	900
LOCKOUT TIMEOUT (MINUTES)	5
INACTIVITY TIMEOUT (MINUTES)	10
NEW PASSWORD (DAYS)	60
<input type="button" value="SUGGEST DEFAULTS"/> <input type="button" value="APPLY"/>	

PASSWORD AUTHENTICATION MODULE – Enables PAM (Password Authentication Module). Password policy settings apply to both the Linux operating system and the ADM webserver.
[SUGGEST DEFAULTS] – Provides recommended password complexity for secure deployment.
[APPLY] – Saves the ENABLE state and numeric parameters to the configuration.

□ The HTTPS Tab

Parameter	Value
MAX CONNECTIONS (0 = NO LIMIT)	0
MAX CONNECTION TIME (MINUTES 0 = NO LIMIT)	0
MAX IDLE TIME (MINUTES 0 = NO LIMIT)	0

SET HTTPS

MAX CONNECTIONS – Sets the absolute maximum number of TCP connections to the ADM web server. (Note: It is common for web-browsers to open parallel TCP connections in order to load the different resources faster, e.g., Chrome browser supports 17 TCP connections).

MAX CONNECTION TIME – How long this connection can continue before requiring another login.

MAX IDLE TIME – Maximum time between commands before requiring another login.

[SET HTTPS] - Configures the three parameters.

□ The CERT Tab

```

CURRENT CERTIFICATE

Version : 3 (0x2)
Signature Algorithm : sha256WithRSAEncryption
Issuer : C=US, ST=Connecticut, L=Milford,
O=Thinklogical/emailAddress=support@thinklogical
Not Before : May 6 19:44:35 2022 GMT
Not After : Sep 20 19:44:35 2049 GMT
Subject : C=US, ST=Connecticut, L=Milford,
O=Thinklogical/emailAddress=support@thinklogical.com
Public Key Algorithm : rsaEncryption
Public-Key : (2048 bit)
Exponent : 65537 (0x10001)
CA : FALSE
DNS : cert_source_test
    
```

CURRENT CERTIFICATE - Provides details of the webserver(s) SSL certificate (encryption algorithm, issuer, expiration date, certificate authority, DNS name).

[IMPORT/INSTALL] - Enables importing locally stored SSL certificate files to the SMP. Naming convention must be “thinklogical.pem” and “thinklogical.crt”.

□ The FIPS Tab

FIPS - Federal Information Processing Standards

ENABLE – Enables FIPS (Federal Information Processing Standards).

[APPLY] - Enables / disables FIPS boot environment variable, requires reboot to change FIPS mode.

SELF CHECK – Displays the results of the TEST button.

KERNEL – Verifies the Linux kernel version supports fips (4.14.187-tl.fips.1) and that the boot environment variable for FIPS is set to '1' (enabled).

NODE COMPLIANCE – Verifies that the HTTPS web server only supports FIPS compliant algorithms via a known answer test.

CRYPTOGRAPHIC BOUNDARY – The integrity of the ARM32 hardware and the RHEL FIPS 140-2 object modules are validated by comparing a calculated HMAC's of the FIPS OPEN-SSL libraries with a stored HMAC file computed at build time.

RANDOM NUMBER – The random number generator test performs 1000 tests to ensure results are uniformly distributed, uncorrelated, and non-repeating.

[TEST] - Performs FIPS integrity checks and reports results.



Note: SELF CHECK is performed on power-up and on-demand. If FIPS is enabled and SELF CHECK fails during boot-up, the Linux kernel will halt.

□ The FIREWALL Tab

ENABLE FIREWALL – Please refer to the **Firewall (UFW) Settings** section of the **Thinklogical TLX Military Unique Deployment Guide** prior to enabling the default firewall policy.

ENABLE SSH – Enables / disables the ability to SSH into the SMP.

[APPLY] – Enables / disables the FIREWALL policy and management of the equipment via SSH protocol.

STATUS - Displays the current FIREWALL status/configuration.

[REFRESH] – Refreshes the current FIREWALL status/configuration.



Note: In order to disable SSH the Firewall must be enabled.

□ The BANNER Tab

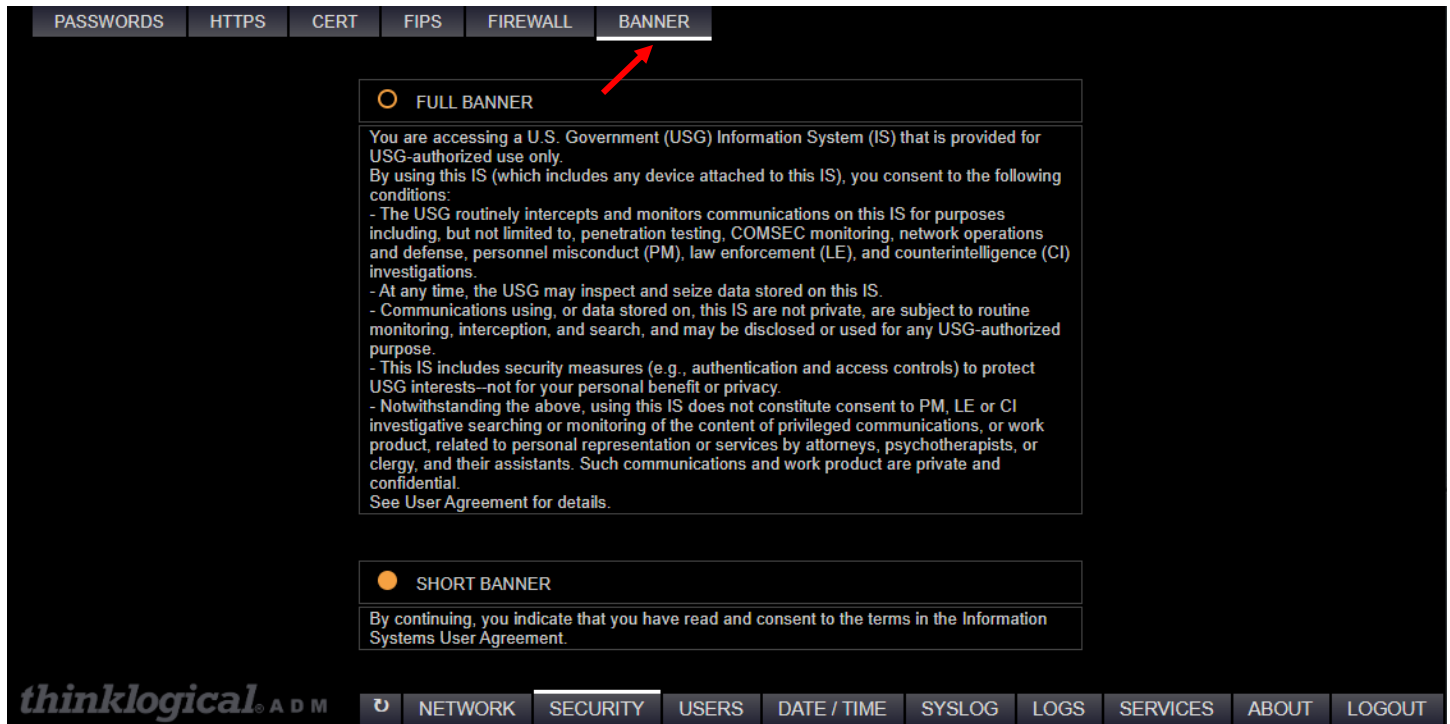

Selected banner will be shown in the splash page during browser login and in the terminal window during SSH login (if SSH login enabled)

□ The USERS Tab

□ The LINUX Tab

Linux user account information.

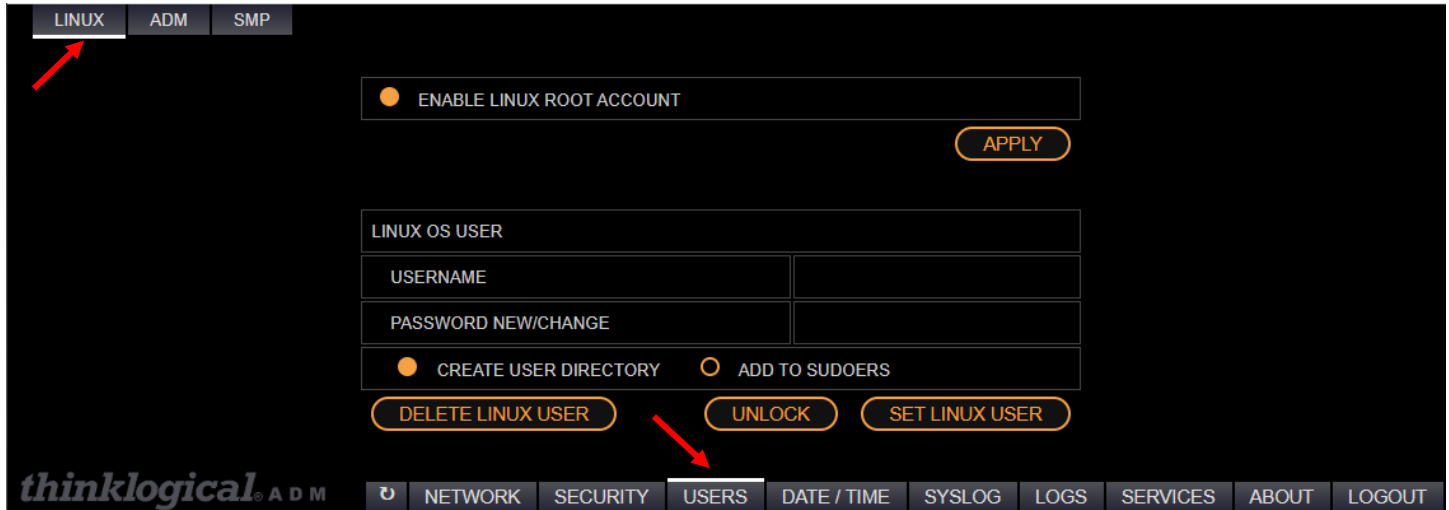

ENABLE LINUX ROOT ACCOUNT – Enables / disables ROOT access via SSH and Serial Console port.

USERNAME – Linux username being configured.

PASSWORD NEW/CHANGE – Enter new password here.

CREATE USER DIRECTORY – Adds a home directory for the specified user, /home/<username>.

ADD TO SUDOERS – Enables/disables superuser privileges.

[DELETE LINUX USER] – Removes specified Linux user account.

[UNLOCK] – Unlocks an account that has been disabled due to excessive failed password entry attempts.

[SET LINUX USER] - Applies USERNAME, PASSWORD, USER DIRECTORY, and SUDO membership.

Clicking in the **USERNAME** field will display a menu of currently configured Users, see example below.

If the password does not meet the requirements, a dialog box will appear.

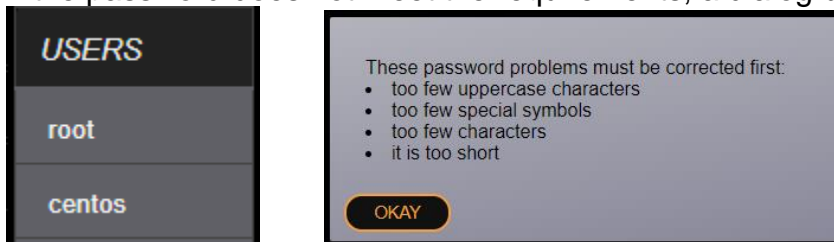

 **Note:** The user “*root*” will not be able to be deleted.

□ The ADM Tab

ADM webserver password configuration.

USERNAME – ADM web page login username.

PASSWORD NEW/CHANGE – Enter new password here.

[SET WEB ADMIN] - Sets new password for admin user.



Note: If MACsec is enabled, the VIRTUAL, PRIMARY, and BACKUP addresses should be part of the MACsec LAN group. If DIP SWITCH (reference NETWORK / ETH0 tab) is enabled, the VIRTUAL, PRIMARY and BACKUP shall be automatically assigned (per DIP SWITCH value).

□ The SMP Tab

SMP webserver password configuration.



Note: The SMP *admin* user configuration is a shared account with the DASHBOARD webserver.

[SET SMP USER] – Sets new passwords for users defined by the SMP webserver tabs ADMIN/USERS.

USERNAME – SMP web page login username.

PASSWORD NEW/CHANGE – Enter new password here.

[UNLOCK] – Unlocks an account that has been disabled due to excessive failed password entry attempts.

□ The DATE / TIME Tab

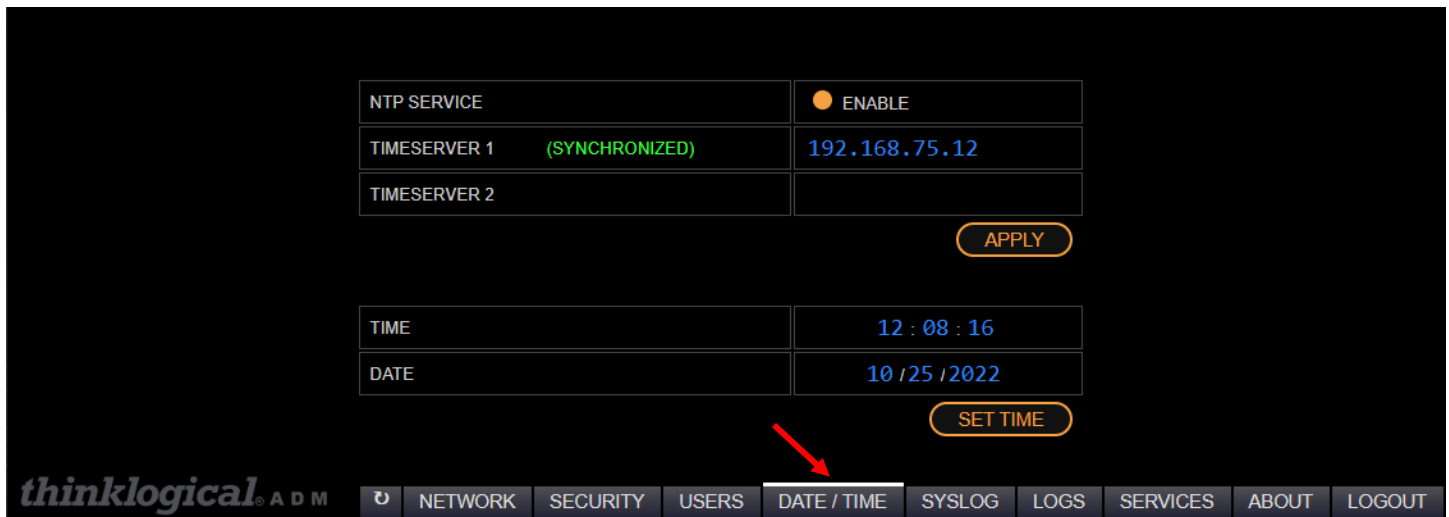

NTP SERVICE – Enabled: Network Time Protocol client periodically requests timing information from a NTP server. The client synchronizes to the server every 64 seconds minimum, 1024 seconds maximum.

TIME SERVER 1 – IP address of primary NTP server.

TIME SERVER 2 – IP address of backup NTP server.

(SYNCHRONIZED) – Indicates which timeserver the unit is synchronized to.

[APPLY] - Configures NTP parameters.

TIME – Configurable system clock, synchronized to NTP server.

DATE – Configurable system date, synchronized to NTP server.

[SET TIME] - Configures system TIME & DATE when entered manually (no timeserver).



Note: When enabling the NTP Service it will not take effect immediately and will take some time to synchronize.

□ **The SYSLOG Tab**

SYSLOG – standard message logging protocol, enabling the recording of security, analytical, debug, and informational messages.

□ **The AUDIT LOGGING Tab**

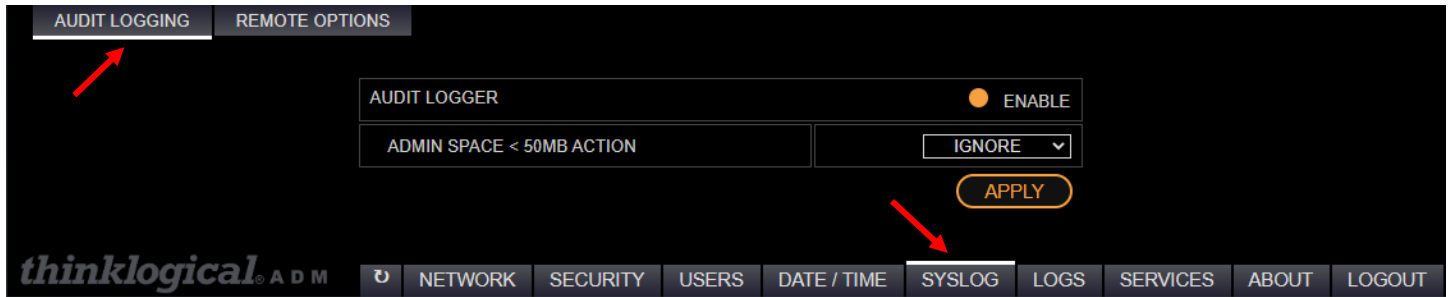

AUDIT LOGGER – A security relevant log providing documentary evidence of potentially suspicious events: authentication, changing file permissions, terminating a process, creating a network connection.

ADMIN SPACE < 50MB ACTION – Action to perform when hard drive partition is less than 50Mbytes.

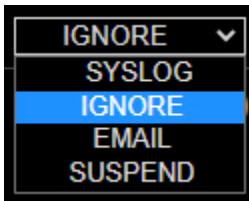

SYSLOG – Send warning to syslog.
 IGNORE – No additional action, ignore warning.
 EMAIL – Email warning to admin account.
 SUSPEND - Stop logging.



Note: Selecting **EMAIL** will provide further configuration options.

AUDIT LOGGER		○ ENABLE
ADMIN REMAINING SPACE LIMIT (MB)	50	
ADMIN SPACE EXHAUSTED ACTION	EMAIL	
RECIPIENT EMAIL	name@gmail.com	
DOMAIN		
ORIGIN		
RELAYHOST		



Note: Refer to **LOGS** tab for viewing / extracting SYSLOG and AUDIT log content.

□ The REMOTE OPTIONS Tab

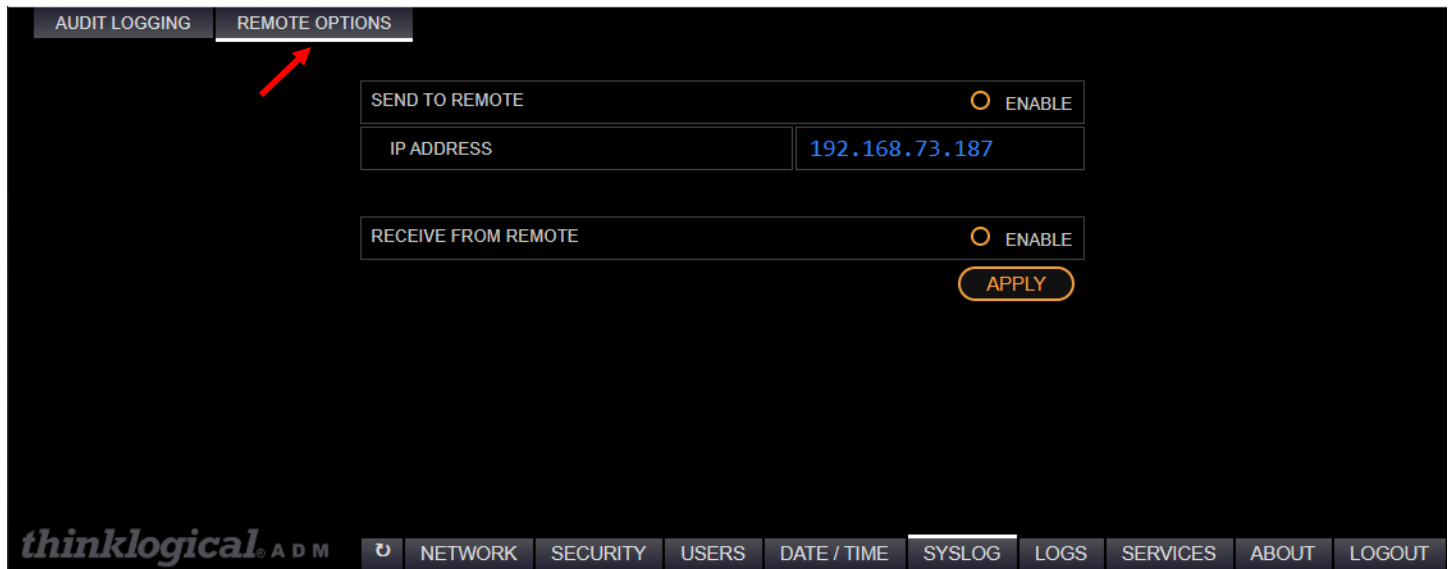

SEND TO REMOTE – ENABLE: Sends SYSLOG messages to a centralized logging server located at <IP ADDRESS> utilizing UDP/IP port 514.

IP ADDRESS – Address of logging server utilizing UDP/IP port 514.

RECEIVE FROM REMOTE - ENABLE: Listens for SYSLOG messages (utilizing UDP/IP port 514) coming from network devices such as TL Matrix and SMP products, and stores data to the SYSLOG file.



Note: ADM prevents ‘SEND TO REMOTE’ and ‘RECEIVE FROM REMOTE’ from being enabled at the same time (prevents recursive logging event).

□ The LOGS Tab

The **LOGS** tab is used for viewing / extracting SYSLOG and AUDIT log content.

LOGS Window - This window contains the filenames of all the logs found in /var/log. They can be filtered by entering a string in the **Filter** field. Select the log(s) for download/inspection.

Filter - Allows filtering by line



Note: Log files are typically downloaded and then emailed to Thinklogical for analysis. Most of the log files shown are standard Linux logs.

Exceptions are the Thinklogical logs:

- tl-adm.log
- tl-dash.log
- tl-smp2.log

□ The DOWNLOAD SELECTED Tab



This feature will compress the selected logs into a TGZ file and send it to your device. Typically in the /Downloads directory on your PC.

□ The DISPLAY LIVE Tab

The screenshot shows the thinklogical ADM interface. At the top right, there are buttons for 'DOWNLOAD SELECTED' and 'DISPLAY LIVE', with a red arrow pointing to the latter. Below this is a 'LOGS' section with a 'Filter' dropdown and a list of log files with radio buttons. The 'tl-smp2.log' file is selected. To the right, a window titled 'tl-smp2.log' displays the log content in real-time. The log content includes timestamps, user names, and system events. At the bottom, a navigation bar contains buttons for 'NETWORK', 'SECURITY', 'USERS', 'DATE / TIME', 'SYSLOG', 'LOGS', 'SERVICES', 'ABOUT', and 'LOGOUT'.

This is a Toggle - This option will display the selected log(s) in real time. If more than one log is selected, they will appear in their own frame. Deselect “DISPLAY LIVE” button to stop updating.

 - Closes the window for that log.



Note: In time, the logs will “roll over” to .GZ files. These are not viewable here but may be downloaded for analysis.

□ The SERVICES Tab

IMPORT / INSTALL				
SYSTEM MANAGEMENT PORTFOLIO	tl-smp2	ACTIVE	RESTART	DISABLE
REDUNDANCY	keepalived	STOPPED	RESTART	DISABLE
TLD	tld	ACTIVE	RESTART	DISABLE
DASHBOARD	tl-dash	ACTIVE	RESTART	DISABLE
NTP	ntpd	ACTIVE	RESTART	DISABLE
POSTFIX	postfix	DISABLED	RESTART	DISABLE
ADM	tl-adm	ACTIVE	RESTART	

RSA SIGNATURE TEST REQUIRED

thinklogical ADM | NETWORK | SECURITY | USERS | DATE / TIME | SYSLOG | LOGS | **SERVICES** | ABOUT | LOGOUT

SYSTEM MANAGEMENT PORTFOLIO - Check the status, restart, stop, or install/reinstall the program that controls matrix switching.

REDUNDANCY - This service runs in the background on redundant systems.

TLD - This service is necessary for the DASHBOARD program.

DASHBOARD - Display status and manage settings for extenders.

NTP - Network Time Protocol service.

POSTFIX - Routes and delivers email to external accounts.

ADM - This program.

IMPORT / INSTALL - Provides the ability to update to a new version of the applicable services

RSA SIGNATURE TEST REQUIRED - Enforces a secure verification method of the software files prior to installation (requires import of RSA INSTALLATION file).

□ The ABOUT Tab



Clicking on the ABOUT tab on any of the pages will show the ADM version below and also add descriptive information about that page. For example: NETWORK / HOSTNAME is illustrated above.

□ The LOGOUT Tab

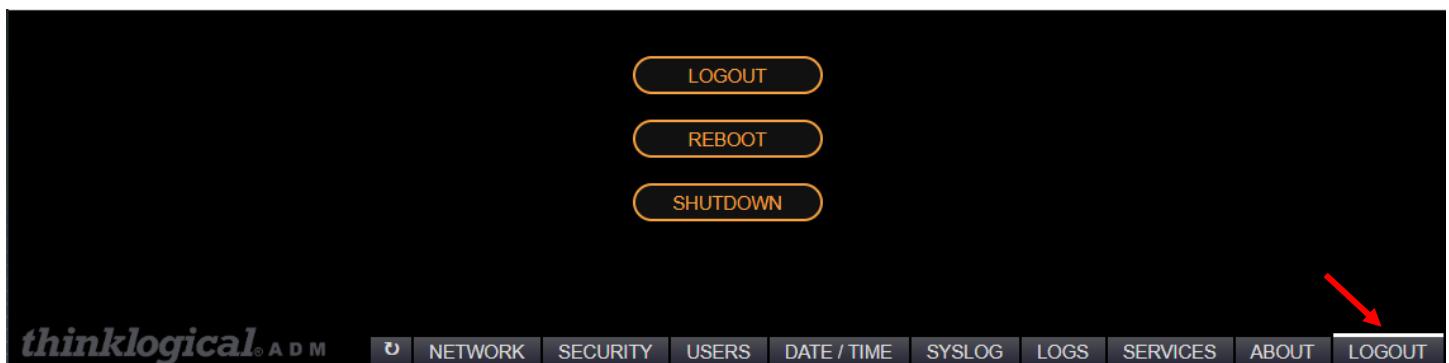

[LOGOUT] - Logs out of the TL ADM webserver.

[REBOOT] - Reboots this Linux machine.

[SHUTDOWN] - Halts this Linux machine (for poweroff).



Warning! The SHUTDOWN operation is required before powering off the SMP otherwise damage may result.

- **LS conn** - Low speed connected.
- **Coll** - Collaboration enabled for this port.
- **OOB** - Out Of Band enabled.
- **DDC** - Indicates the DDC mode selected for the Tx extender.
- **Int Ms** - Indicates whether the *Intuitive Mouse* feature is enabled.
- **L1** - Power level of L1.
- **L2** - Power level of L2.
- **L3** - Power level of L3.
- **L4** - Power level of L4.
- **L5** - Power level of L5.
- **Alarm** - Indicates an alarm condition reported from the extender. Left-click for details.
- **Last Alarm** - Indicates the date and time of the latest alarm condition. Left-click on an entry to clear it. Right-click on the heading to clear all.
- **Count** - Number of packets received during the last scan.
- **Time** - Time of the last scan.

The **MONITOR** application scans each selected port approximately once per second and records the results. With large numbers of ports, this could take some time. It may be desirable to Hide some ports so not all are scanned at once. Also, the second MONITOR connection to the SMP3 Appliance may be enabled and connected to the switch to double the frequency of port monitoring to two ports per second.

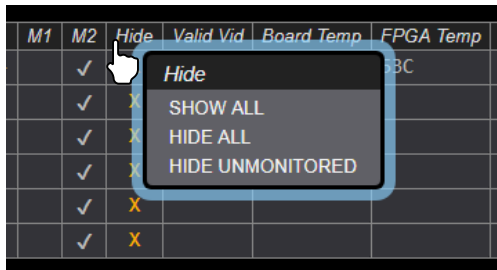

Right-click on Hide and a drop-down allows show/hide options for the entire window.



Note: Users may left-click on any column heading to sort *in ascending order*.

□ The Transmitter (TX) Tab

TX		RX		MTX		EXPORT																REFRESH						
Port	Src Name	Portname	Product ID	Serial	M1	M2	Hide	Valid Vid	Board Temp	FPGA Temp	LS Conn	DDC	Int Ms	A Logout	SFP 1R	SFP 1T	SFP 2R	SFP 2T	SFP 3R	SFP 3T	SFP 4R	SFP 4T	Pri Sec	Alarm	Last Alarm	Count	Time	
A_1(R)	ALPHA	VidA(R)/Kbs(R)/Aud(R)					X																					
A_2(R)	ALPHA	VidB(R)					X																					
A_3(R)	BETA	VidA(R)/Kbs(R)/Aud(R)					X																					
A_4(R)	BETA	VidB(R)					X																					
A_5(R)	CHARLIE	VidA(R)/Kbs(R)/Aud(R)					X																					
A_6(R)	CHARLIE	VidB(R)					X																					
A_7(R)	DELTA	VidA(R)/Kbs(R)/Aud(R)					X																					
A_8(R)	DELTA	VidB(R)					X																					

thinklogical SYSTEM MANAGEMENT DASHBOARD

MONITOR FIRMWARE SETTINGS ABOUT LOGOUT

□ The Receiver (RX) Tab

TX		RX		MTX		EXPORT																REFRESH						
Port	Dst Name	Portname	Product ID	Serial	M1	M2	Hide	Valid Vid	Board Temp	FPGA Temp	LS Conn	OOB	Coll	Int Ms	SFP 1R	SFP 1T	SFP 2R	SFP 2T	SFP 3R	SFP 3T	SFP 4R	SFP 4T	Pri Sec	Alarm	Last Alarm	Count	Time	
A_20(R)	DESK 2-kbd	Kbd(R)					X																					
A_25(R)	DESK 1-kbd	Kbd(R)					X																					

thinklogical SYSTEM MANAGEMENT DASHBOARD

MONITOR FIRMWARE SETTINGS ABOUT LOGOUT

□ The MTX (Matrix Switch) Tab

This tab provides detailed information on matrix switches connected to the network the SMP is on.

Note: Image below is from an SMP Module and therefore does not have TX and RX tabs.

IP	Name	Type	SysName	SW Version	FPGA Rev	I/O Installed	Primary Ctrl	Backup Ctrl	PwrS	Active Ports	Ports	Temp	LOS	TxPwr	RxPwr	Uptime	Alarm	Last Alarm	Last Connection
192.168.73.72		TLX80Router	tlx-80-ubu-pri	V5.09.06	1.02.0f	1-16	active	standby	2	1	80	32C	↗	↗	↗	6.0d	ok		13:43:28 03/19
192.168.73.75		TLX160Router	tlx-160-ubu-pri	V5.09.06	1.00.0f	1-10,12-16	active	standby	2	157	160	30C	↗	↗	↗	6.0d	ok		13:43:28 03/19
192.168.73.95		TLX80Router	tlx80-pri-ubuntu-mch	V5.09.06	1.00.0d	1-7,16	active	standby	2	3	80	28C	↗	↗	↗	21.7d	fail		15:18:00 03/20
192.168.73.191		TLX24Router	imxswitch-test-tlx24	V5.09.06	1.00.0b	1	active		1	1	24	34C	↗	↗	↗	54.8d	ok		15:48:48 02/13

These include:

- IP – Virtual IP address of the matrix
- Name – The matrix name as assigned by the SMP.
- Type – Matrix type.
- SysName – The Linux hostname of the matrix.
- SW version – Matrix controller card software version.
- FPGA Rev – Matrix controller card FPGA version.
- I/O Installed – Which I/O cards are installed in the matrix.
- Primary Ctrl, Backup Ctrl – Operational status of the matrix controller cards.
- PwrS – Installed power supplies.
- Active Ports – Matrix ports that have connections.
- Ports – Total number of ports in the Matrix.
- Temp – Matrix temperature.
- *** LOS – “Loss Of Signal” – Indicates there is no signal coming into the matrix port.
- *** TxPwr – Transmit power level.
- *** RxPwr – Receive power level.
- Uptime – Since the matrix was powered up.
- Alarm – Current alarm condition. Clicking on this field will provide further detail.
- Last Alarm – Timestamp of alarm.
- Last Connection – Latest matrix switch modification. I.e: connect or disconnect.

*** - Clicking on the  icon will display a table of values, for example:

PORT#	1	2	3	4	5	6	7	8	9	10
1-10	396	454	460	2	0	467	477	2	2	0
11-20	2	502	2	0	0	1	529	458	2	2
21-30	2	3	2	2	2	0	0	0	1	1
31-40	0	0	0	0	0	0	0	0	0	0
41-50	0	0	0	0	0	0	0	0	0	0
51-60	0	0	0	0	0	0	0	0	0	0
61-70	0	0	0	0	0	0	0	0	0	0
71-80	0	0	0	0	0	429	458	0	467	453

Sample Alarm;

This could indicate that there is no AC power to power supply #2:

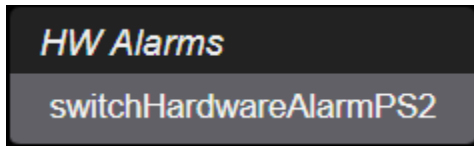

□ The FIRMWARE Tab

This feature allows firmware updates to be downloaded to extender modules directly from the **SMP3 Appliance or SMP3 Module**. Some extenders do not provide this information, so some table entries may be blank. *This feature is supported on TLX Extenders, E-series only.*

Prior to this operation, obtain the correct firmware update from Thinklogical Technical Support (1-203-647-8700) and copy the file to a location in the `/opt/tl/updates` directory.

 **Note:** It is possible that the files in this directory may not be later versions than what you have installed. Check with Thinklogical Technical Support before updating.

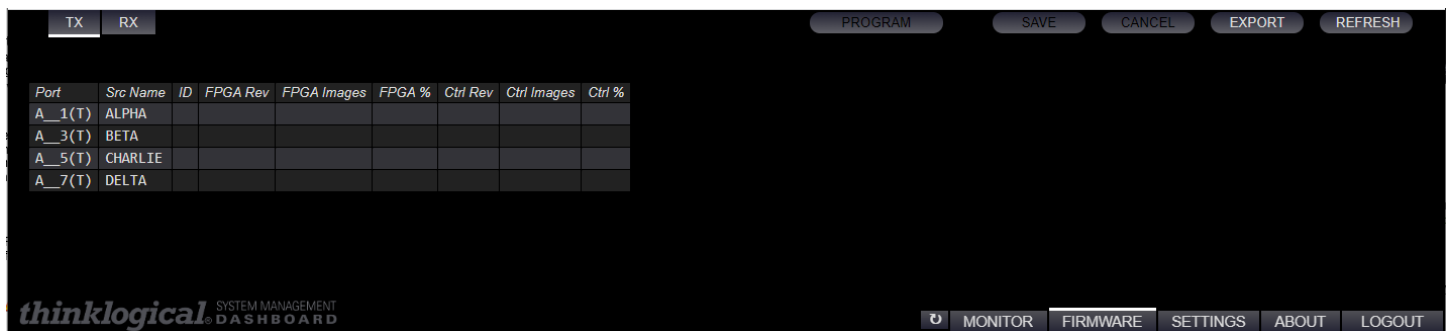

□ The SETTINGS Tab

 **Note:** This tab is only supported by SMP3 Appliances with 10G optics (TLX). The features described here apply to E-series TLX Extender modules.

□ The Transmitter (TX) Tab

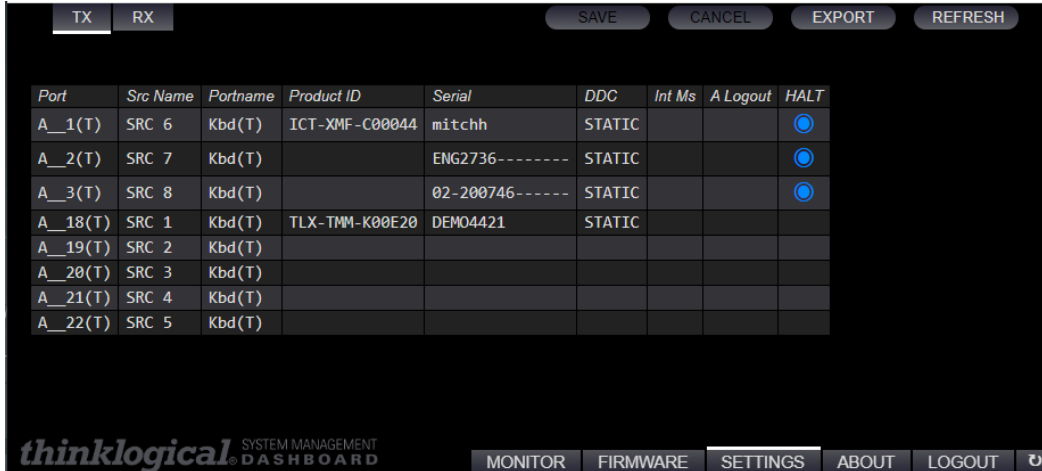

Port	Src Name	Portname	Product ID	Serial	DDC	Int Ms	A Logout	HALT
A_1(T)	SRC 6	Kbd(T)	ICT-XXF-C00044	mitchh	STATIC			<input checked="" type="radio"/>
A_2(T)	SRC 7	Kbd(T)		ENG2736-----	STATIC			<input checked="" type="radio"/>
A_3(T)	SRC 8	Kbd(T)		02-200746-----	STATIC			<input checked="" type="radio"/>
A_18(T)	SRC 1	Kbd(T)	TLX-TMM-K00E20	DEMO4421	STATIC			
A_19(T)	SRC 2	Kbd(T)						
A_20(T)	SRC 3	Kbd(T)						
A_21(T)	SRC 4	Kbd(T)						
A_22(T)	SRC 5	Kbd(T)						

Allows users to view such settings as:

Matrix port, Source name, Port name, Extender type, Serial Number.

Also:

- DDC mode
- Intuitive Mouse setting.
- Autologout Setting.
- HALT mode.

□ The Receiver (RX) Tab



Port	Dst Name	Portname	Product ID	Serial	OOB	Coll	Int Ms	Flex Keys
A_6(T)	DST 3	Kbs(T)/Vid(T)						
A_7(T)	DST 4	Vid(T)						
A_8(T)	DST 5	Vid(T)						
A_11(T)	Kbd 4	Kbs(T)						
A_12(T)	Kbd 5	Kbs(T)						
A_16(T)	DST 2	Kbs(T)/Vid(T)						
A_17(T)	DST 1	Kbs(T)/Vid(T)						

Allows users to view the settings above and:

- OOB – Out Of Band setting.
- Collaboration setting.
- Intuitive Mouse setting.
- Flexkeys.

FLEX CODE				MODIFIER KEYS		KEY (optional)			
11	66	85	95	L_CTRL	R_CTRL	F1	F6	1	6
22	81	86	96	L_SHFT	R_SHFT	F2	F7	2	7
44	82	87	97	L_ALT	R_ALT	F3	F8	3	8
55	83	88	98	L_CMD	R_CMD	F4	F9	4	9
XX	84	89	99	DBL	SCROLL	F5	F10	5	0
(clear selected code)				USE DEFAULTS		PROGRAM EXTENDER			

In the SETTINGS Tab's RX tab, left-click in FlexKeys above, to get the *FLEX CODE* drop-down menu, left. Set up FlexKeys from here.



□ The ABOUT Tab

This tab displays the version of Dashboard installed and running.



□ The LOGOUT Tab

This tab logs out of the Dashboard and presents the login page.

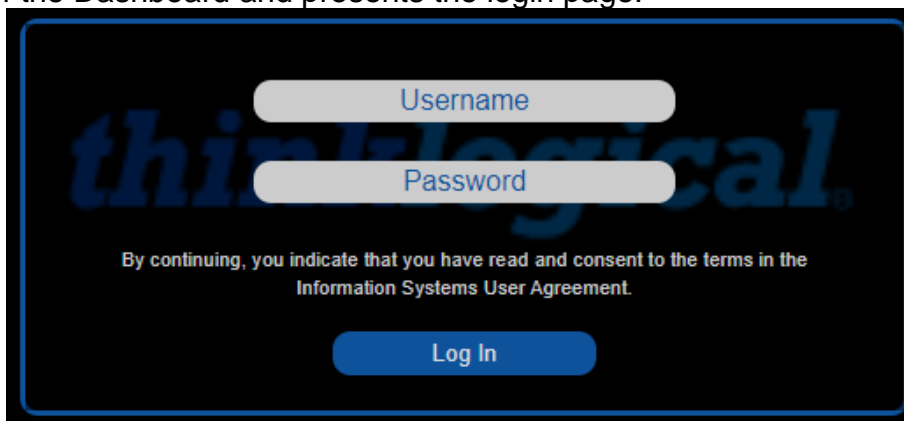

Regulatory Compliance

Symbols Found on Our Products

Markings and labels on our products follow industry-standard conventions. Regulatory markings found on our products comply with all required domestic and many international requirements.

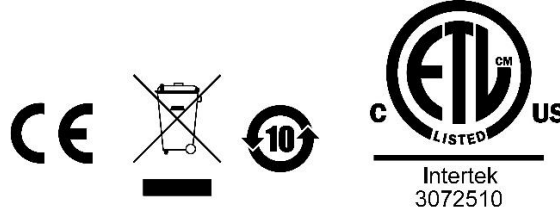

Regulatory Compliance

Thinklogical's products are designed and made in the U.S.A. These products have been tested by a certified testing laboratory and found compliant with the following standards for both domestic USA and many international locations:

North America

Safety

ANSI/UL60950-1: 1st Edition (2003)

CAN/CSA C22.2 No. 60950-1-03

CENELEC EN 60950-1, 1st Edition (2001)

LASER Safety

CDRH 21CFR 1040.10

Class 1 LASER Product

IEC60825:2001 Parts 1 and 2

Class 1 LASER Product

Electromagnetic Interference

FCC CFR47, Part 15, Class A

Industry Canada ICES-003 Issue 2, Revision 1

Australia & New Zealand

This is a Class A product. In a domestic environment this product may cause radio interference, in which case the user may be required to take corrective action.

European Union

Declaration of Conformity

Manufacturer's Name & Address:

Thinklogical, A BELDEN BRAND

100 Washington Street

Milford, Connecticut 06460 USA

These products comply with the requirements of the Low Voltage Directive 72/23/EEC and the EMC Directive 89/336/EEC, the RoHS Directive 2011/65/EU, the WEEE Directive 2012/19/EU and carry the **CE** marking accordingly.

Standards with Which Our Products Comply

Safety

CENELEC IEC 60950-1 2nd Ed. 2005

Electromagnetic Emissions

EN55022: 1994 (IEC/CSPIR22: 1993)
 EN61000-3-2/A14: 2000
 EN61000-3-3: 1994

Electromagnetic Immunity

EN55024: 1998 Information Technology Equipment-Immunity Characteristics
 EN61000-4-2: 1995 Electro-Static Discharge Test
 EN61000-4-3: 1996 Radiated Immunity Field Test
 EN61000-4-4: 1995 Electrical Fast Transient Test
 EN61000-4-5: 1995 Power Supply Surge Test
 EN61000-4-6: 1996 Conducted Immunity Test
 EN61000-4-8: 1993 Magnetic Field Test
 EN61000-4-11: 1994 Voltage Dips & Interrupts Test

Supplementary Information

The following statements may be appropriate for certain geographical regions and might not apply to your location:

- This Class A digital apparatus meets all requirements of the Canadian Interference-Causing Equipment Regulations. *Cet appareil numérique de la classe A respecte toutes les exigences du Règlement sur le matériel brouilleur du Canada.*
- This is a Class A product. In a domestic environment, this product may cause radio interference, in which case the user may be required to take corrective action.
- This equipment has been tested and found compliant with the limits for a Class A digital device, pursuant to part 15 of the FCC Rules. These limits are designed to provide reasonable protection against harmful interference when the equipment is operated in a commercial environment. This equipment generates, uses and can radiate radio frequency energy and, if not installed and used in accordance with the instruction manual, may cause harmful interference to radio communications in which case the user may be required to make adequate corrective measures at their own expense.
- This Class A digital apparatus complies with Canadian ICES-003 and has been verified as compliant within the Class A limits of the FCC Radio Frequency Device Rules (FCC Title 47, Part 15, Subpart B Class A), measured to CISPR 22:1993 limits and methods of measurement of Radio Disturbance Characteristics of Information Technology Equipment.
- The user may notice degraded audio performance in the presence of electro-magnetic fields.

Product Serial Number

Thinklogical products have a unique serial number, which includes a date-code, printed on an adhesive label that is affixed to the unit. The format for the date-code is *2 digits for the month, dash, 2 digits for the year, plus at least four digits for a unique unit number.* For example:

09-220128 indicates the unit was built in the **9th** month of **2022** and is unit number **128**.

Connection to the Product

Connections and installation hardware for our products use industry-standard devices and methods. All wiring connections to the customer equipment are designed to minimize proprietary or customized connectors and cabling. Power connections are made with regionally appropriate power cords and approved methods.

Thinklogical Support

Customer Support

- **Website:** <https://www.thinklogical.com/downloads/>

Visit our website for current products, support documents and useful information about all the products and services we offer, including:

- **FPGA Update Guides**
- **Quick-Start Guides**
- **User Manuals** (for viewing online or for download)
- **Visio Stencils**
- **Chat Live** with a Technical Support Representative.

Technical Support

For product support, technical issues/questions, product repairs or request for Return Merchandise Authorization, use any of the following methods:

- **Email:** support@thinklogical.com – (preferred)
- **Telephone:** **1-203-647-8700** or **1-800-291-3211** - Monday-Friday from 8:30am to 5:00pm, Eastern Time Zone.

Product Support

Warranty

Thinklogical warrants this product against defects in materials and workmanship for a period of one year from the date of delivery, with longer terms available at the time of purchase on most products. Thinklogical and its suppliers disclaim all other warranties. Please refer to your product invoice for the Warranty Terms & Conditions.

Defect remedy shall be the repair or replacement of the product, provided that the defective product is returned to the authorized dealer within a year from the date of delivery.

Return Authorization

If you wish to return your device, contact the Thinklogical-authorized dealer where you purchased the device, or if you need to return a product to Thinklogical directly, please use the support email above. Support will need the serial number and ask you to describe the issue and will provide you with an RMA number (Return Merchandise Authorization). Pack the device in its original box, if possible, and return it with the RMA# printed on the outside of the box. **DO NOT return a product to Thinklogical without a *Return Merchandise Authorization*.**

Our Address

If you need to write us or return a product, please use the following address:

Thinklogical, A BELDEN BRAND
100 Washington Street
Milford, CT 06460 USA
Attn: RMA#

Please include the Return Merchandise Authorization number.

Appendix A: Ordering / Configuration Guide

S	M	P	—	1	2	3	4	4	4	4
UNIT				1. DEVICE			2. SFP TYPE			
System Management Portfolio				A SMP Appliance M SMP Module C SMP Client I SMP i7 Appliance O SMP i7 Client			0 6G X 10G			
				3. NETWORK SFP			SFP MODE			
				0 Copper Multi-Mode S Copper Single-Mode F Fiber Multi-Mode Z Fiber Single-Mode						
4. PORT LICENSING										
The number of matrix switch ports the SMP is licensed for. This can be any number the customer requires in order to support single or multiple Matrices.										
Examples: - 0000 = No license (Special case) - 0001 = SMP Client (does not have a license) - 0320 = 320 port license - 0640 = One TLX-640 -or- two TLX-320s -or- four TLX-160's. - etc.										

Appendix B: SSL Certificates for HTTPS

Secure Sockets Layer (SSL) Certificates provide secure, encrypted communications between a website (SMP3 web server) and an internet browser. SSL is the protocol that provides encryption. The locations for the SSL certificates and keys on the SMP3 computer are contained in the following two files:

Initial early version:

/etc/ssl/private/SMP2.pem
/etc/ssl/private/SMP2.crt

Current version:

/etc/ssl/private/thinklogical.key
/etc/ssl/private/thinklogical.crt

These original files, SMP3.pem and SMP3.crt, are Thinklogical self-issued certificates and are intended to be place holders for a certificate from a recognized trusted certificate authority, to be installed by the SMP3 administrator.



Note: The file naming convention must be maintained for proper web server operation.

To confirm the certificate's expiration date, perform the following commands:

- 1.) From the Linux command line perform the 'su' command to login as the *root user*.
- 2.) Change the directory to the location of the certificate: `cd /etc/ssl/private`
- 3.) Execute the following command: `openssl x509 -noout -in thinklogical.crt -dates`

To generate new self-issued certificates:

- 1.) From the Linux command line perform the 'su' command to login as the *root user*.
- 2.) Change the directory to the location of the certificate: `cd /etc/ssl/private`
- 3.) Execute the following command:
`openssl req -x509 -nodes -days 9999 -newkey rsa:2048 -keyout thinklogical.pem -out thinklogical.crt`



Note: 9999 days = ~ 27 years.



Note: Once the certificates have been acquired from an authorized source, they should be stored in the location specified above (SSL Certificates), using the exact naming convention shown above.

Appendix C: Key SMP3 File Locations (Accessible by root user only)

Configuration files:

/opt/tl/setup/allocations.csv
/opt/tl/setup/hotkeys.csv
/opt/tl/setup/matrix.txt
/opt/tl/setup/stations.csv
/opt/tl/setup/tags.csv
/opt/tl/setup/tielines.csv
/opt/tl/setup/users.csv
/opt/tl/setup/macros - (directory)

Scripts:

/opt/tl/tools/keepalivedMod.sh
/opt/tl/tools/sync.sh

SSL Certificates:

/etc/ssl/private/thinklogical.key
/etc/ssl/private/thinklogical.crt
/etc/ssl/private/smp2.crt
/etc/ssl/private/smp2.pem

Log files:

/var/log/tl-smp2.log

Appendix D: Enable Hot Keys (Out Of Band)

Connect the PC to the Rx HOST or Chassis UPDATE Port with a USB cable. Hot Keys can be enabled or disabled on a Receiver Module with HID capabilities using the Chassis front panel LCD and Navigation Buttons. See also *Hot Keys* section.

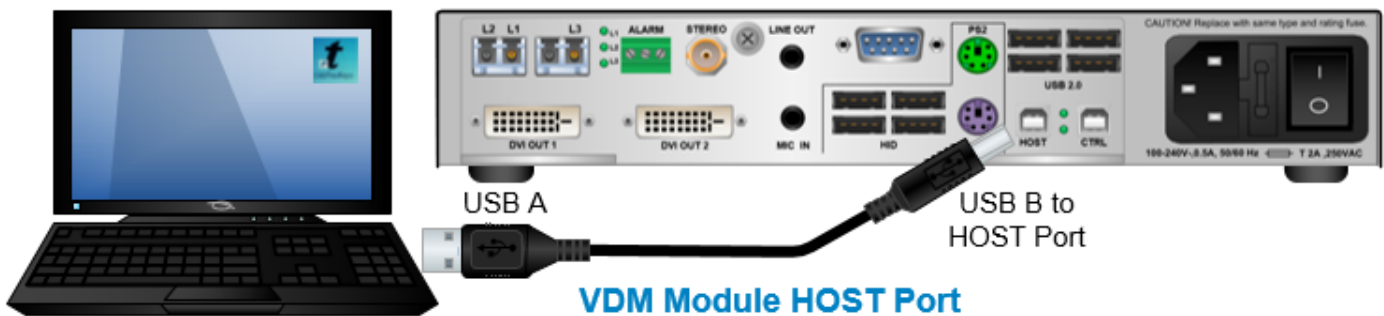
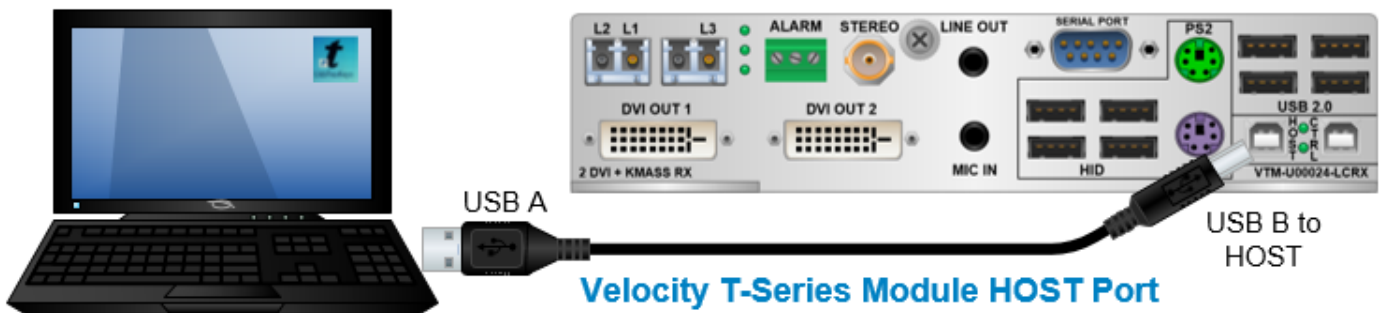
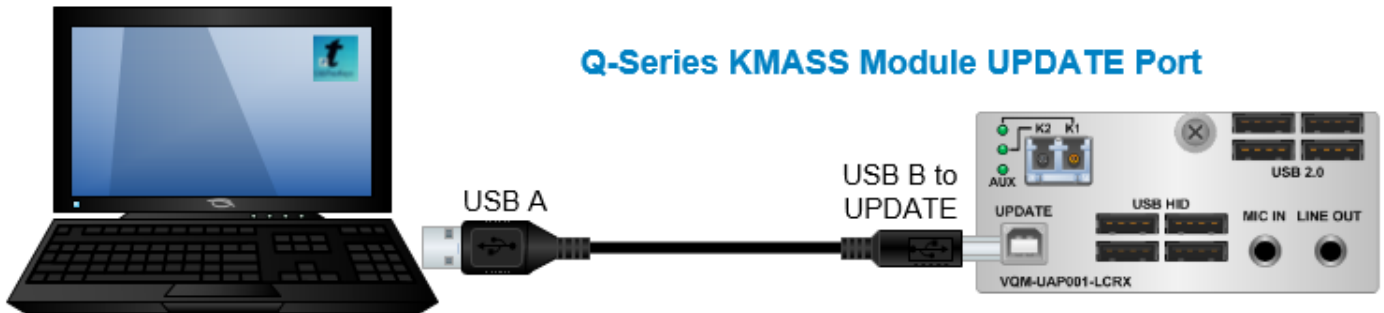

To Enable/Disable Hot Keys, follow the steps below:

Desktop Chassis Front Panel LCD Display

Description

<p>Thinklogical Velocity RX VDM24 V22-21</p> <p>*System</p> <p>Allow Out Of Band Yes/No = NO</p> <p>Allow Out Of Band Yes/No = NO</p> <p>Allow Out Of Band Yes/No = YES</p> <p>Allow Out Of Band Yes/No = YES</p>	<p>At turn-on, chassis type and current revision are displayed.</p> <ul style="list-style-type: none"> ⏴ Scroll Down to the *System menu. ⏴ Press the left arrow button ~3 times to get to the <i>Allow Out Of Band</i> menu. If Out Of Band is disabled, NO will be displayed to the right. enter Press the enter button to select the YES/NO option. The last letter will display an underscore, indicating that it can now be changed or selected. ⏴ Press the up arrow button to toggle to the YES option. The last letter will display an underscore, indicating that it can be changed or selected. enter Press the enter button to select the YES option. The underscore will disappear, indicating that <i>Allow Out Of Band</i> is now enabled.
---	---

CHS-4 and CHS-2 Chassis Front Panel LCD Display

Description

<p>Thinklogical CHS-000004 V23-21</p> <p>Card 2 TLX - RxK U/D = Menus, L/R = Exit</p> <p>*System Parameters</p> <p>Allow Out Of Band Yes/No = NO</p> <p>Allow Out Of Band Yes/No = NO</p> <p>Allow Out Of Band Yes/No = Yes</p> <p>Allow Out Of Band Yes/No = Yes</p>	<p>At turn-on, chassis type and current revision are displayed.</p> <ul style="list-style-type: none"> ⏴ Scroll Down to access the menu for the Receiver Module to be enabled. (Must have HID capability.) ⏴ Scroll Down to the *System Parameters menu. ⏴ Press the left arrow button ~5 times to get to the <i>Allow Out Of Band</i> menu. If Out Of Band is disabled, NO will be displayed to the right. enter Press the enter button to select the YES/NO option. The last letter will display an underscore, indicating that it can now be changed or selected. ⏴ Press the up arrow button to toggle to the YES option. The last letter will display an underscore, indicating that it can be changed or selected. enter Press the enter button to select the YES option. The underscore will disappear, indicating that <i>Allow Out Of Band</i> is now enabled.
---	--

Appendix E: Flex Keys

Flex Keys is a Thinklogical Tool that installs onto a Windows PC. *Flex Keys* gives the administrator the ability to create unique **Hot Keys** to enable actions that are not in Thinklogical's default Hot Key Manager.

Create Unique Flex Key Actions

1. Connect a PC to the **HOST** or **UPDATE** port located on a Thinklogical Q-Series, T-Series or TLX Receiver or Chassis. Any changes will be saved to that Receiver.



Note: Use a USB 2.0 port only. *DO NOT* use a USB 3.0 port.

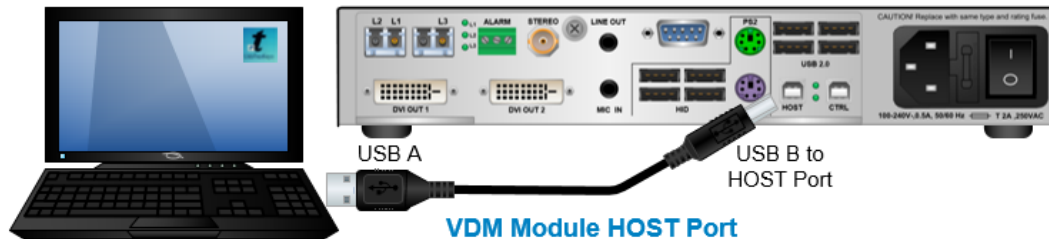
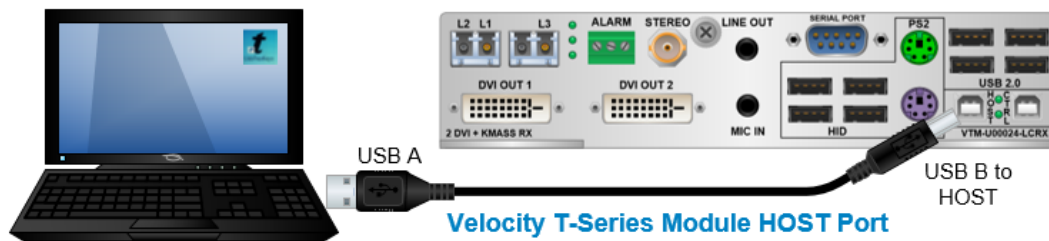
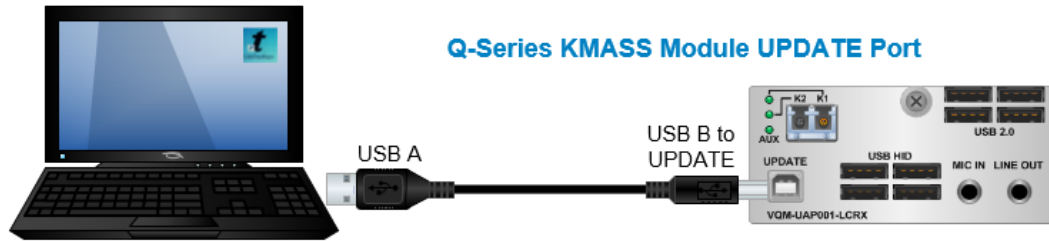

2. Click on the **UsbFlexKeys** icon.



- The saved HOST or UPDATE settings are read here. Click on *Rd Mod* to establish a connection to the Host. Then click on *Read Host Keys* to read the existing Flexkeys from the module. *The default keys are shown here. They may be used as they are or modified for your application.*

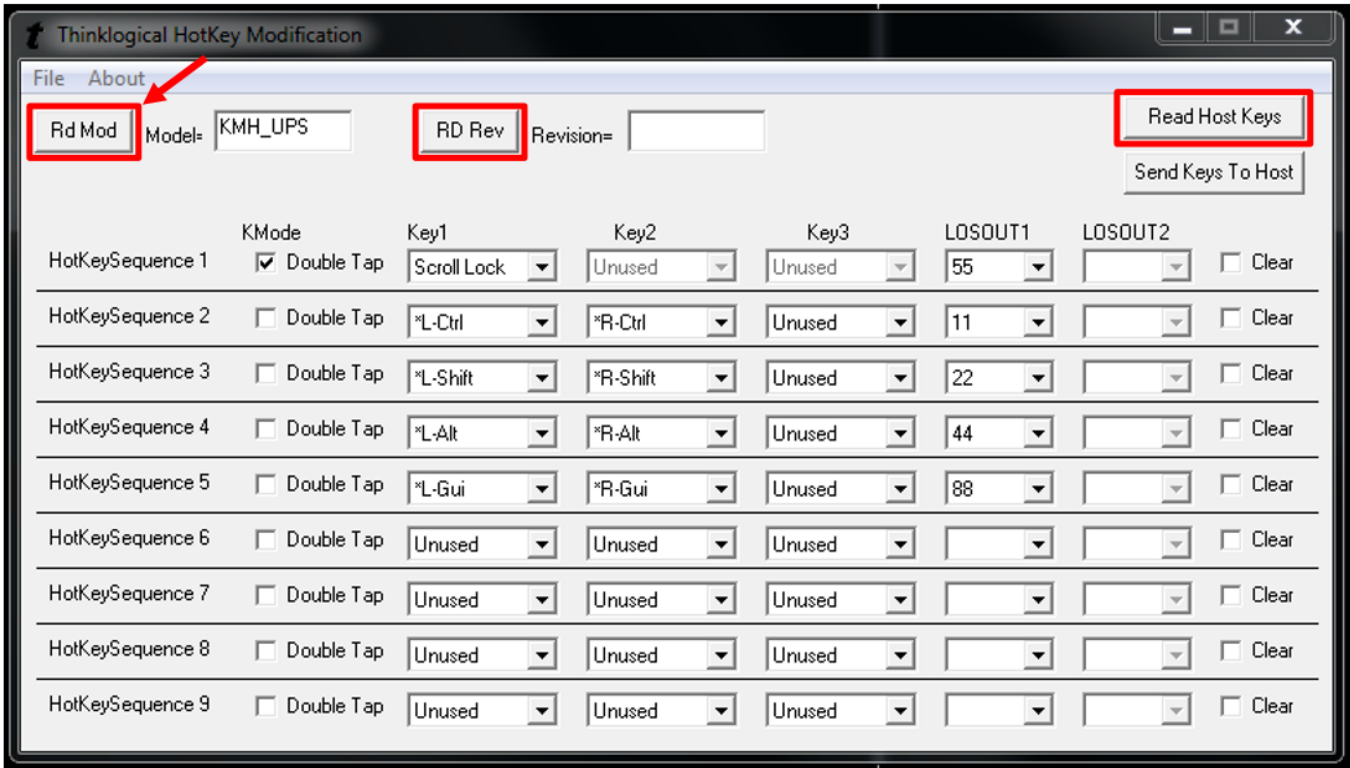

- Left-click on the pull-down menus under *Key1*, *Key2* and *Key3* to select an **action** key.

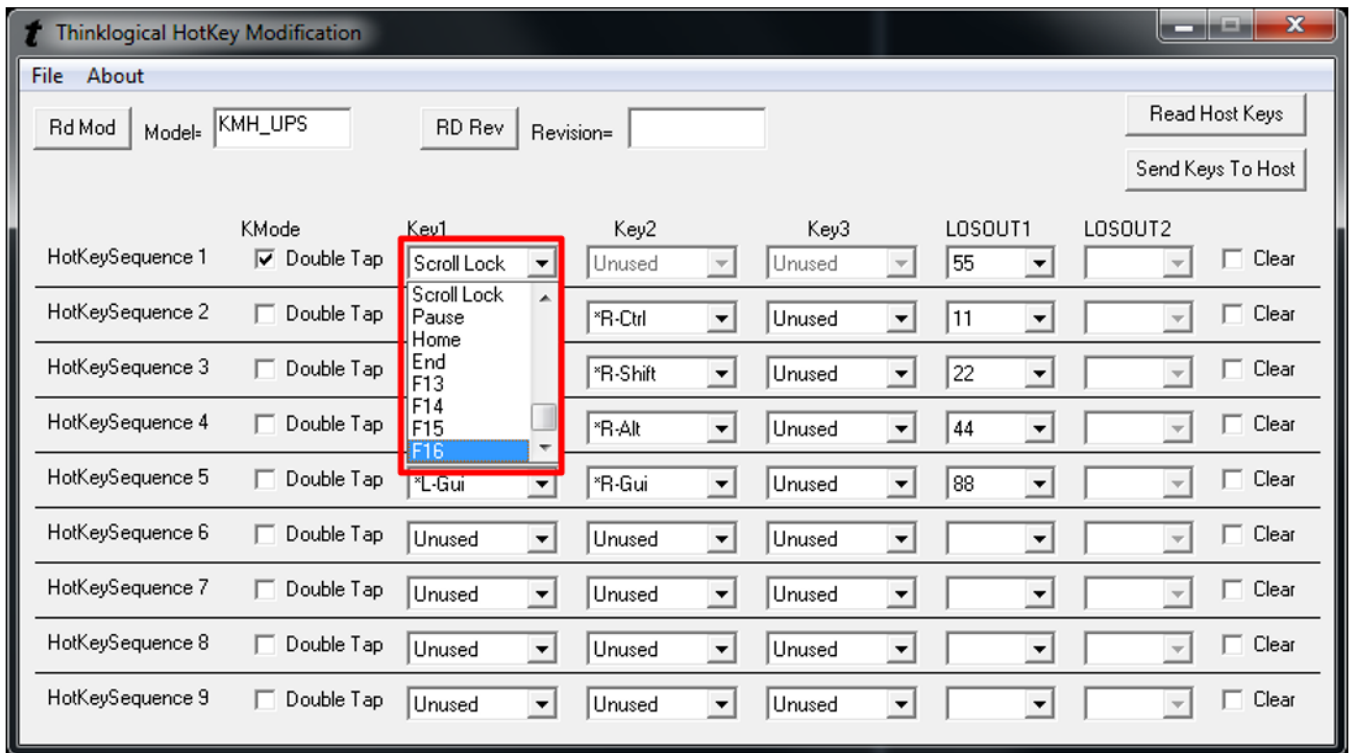

- Select the **code** desired, which may reflect a matching code in the SMP3's Hot Key Manager or may be a unique code for this application. A Code used here must be **entered manually** into the SMP3's Hot Key Manager for the action to be applied. Selecting **Double Tap** (as in "Scroll lock/Scroll lock") requires only one key. Non-Double Tap can use a sequence of up to three keys.

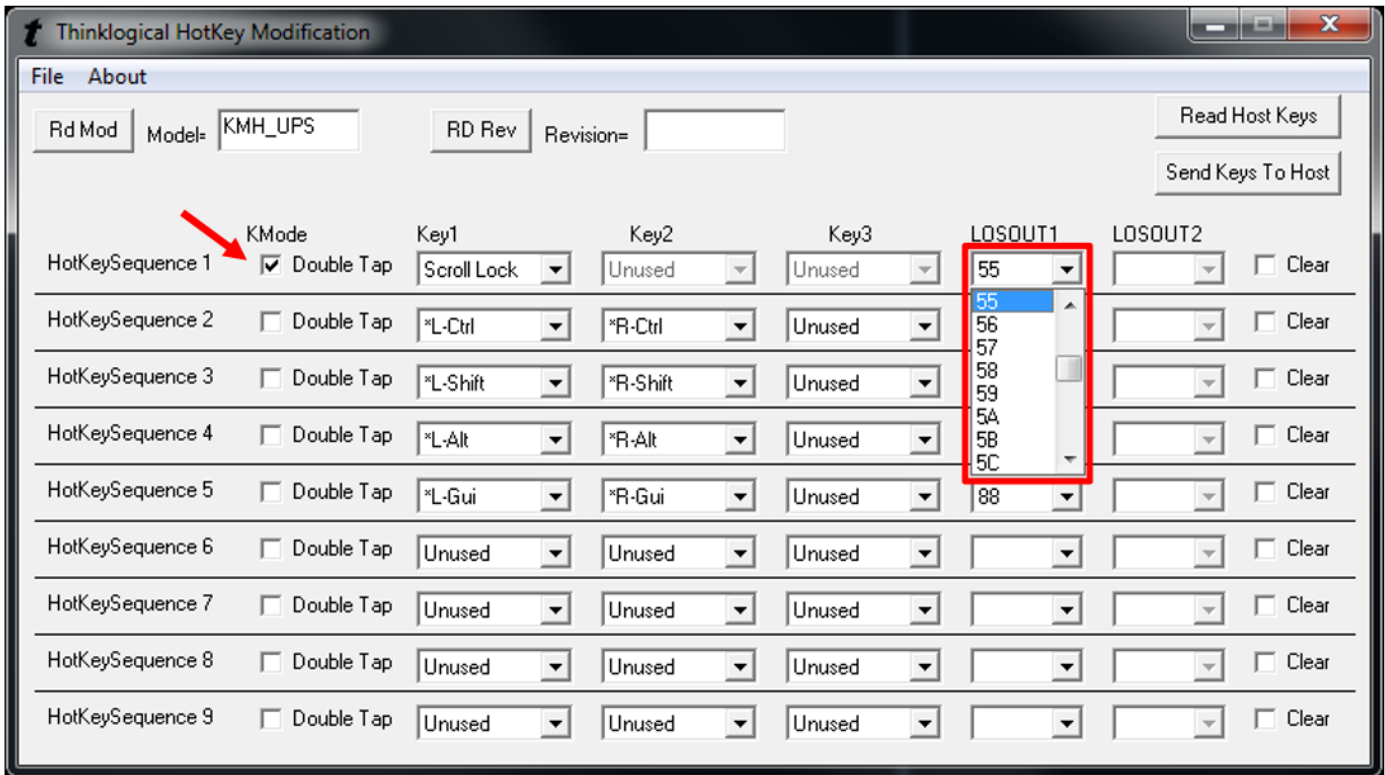

- When the desired settings are selected, click on *Send Keys to Host* to **apply** the new settings.

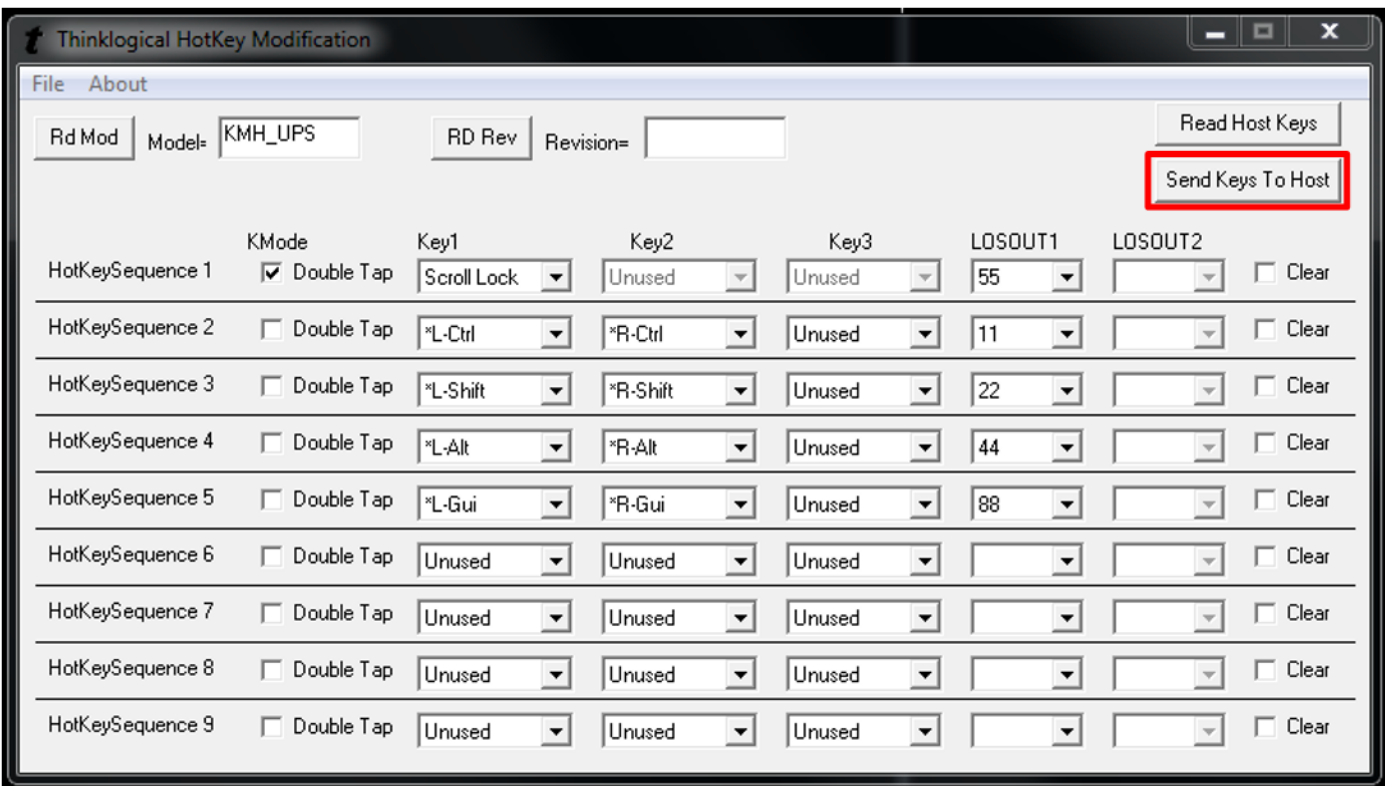

7. To restore a Receiver to its default settings:

- a. Open Flex Keys without reading the device. (No USB cable to the PC.)
- b. Click on *Send Keys to Host*. This will send the default Key Table to the device.
- c. Click on *Rd Mod* to verify that the keys have returned to their default settings.

Or:

- a. Click on *File* (Upper left)
- b. Open **default.conf**
- c. Click on *Save*

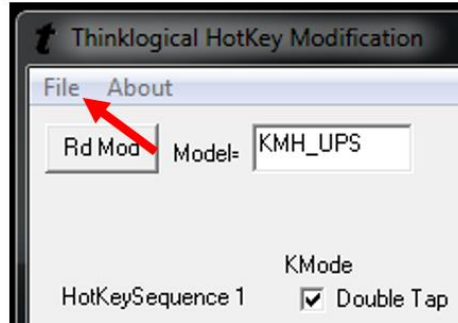

Creating Custom Actions

Some situations may require more than (9) key sequences. Users can then create a special key sequence requiring a two-digit number from 1 to 99, entered by the user.

 **Note:** If using single digit numbers, then 01 through 09 are entered here. Corresponding SMP3 code values in the HOT KEYS tab will be 1-9.

By left-clicking on an “unused” **Key1 drop-down menu**, users can select from a list of key sequences. In this case, *Left Ctrl* is selected for Key 1.

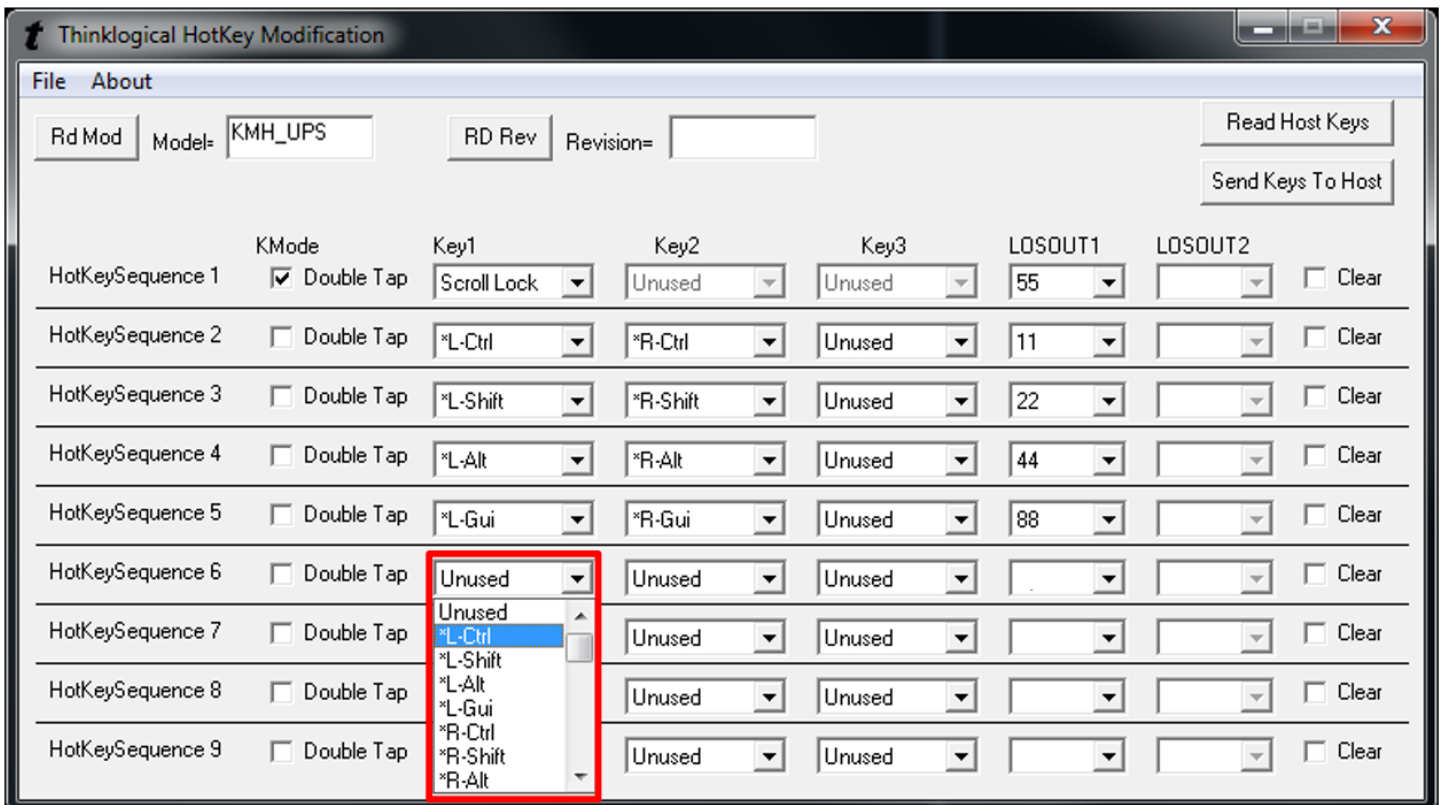

Left-click on the **Key2 drop-down menu** to select the Key 2 sequence. In this case, *F1* is selected for Key 2.

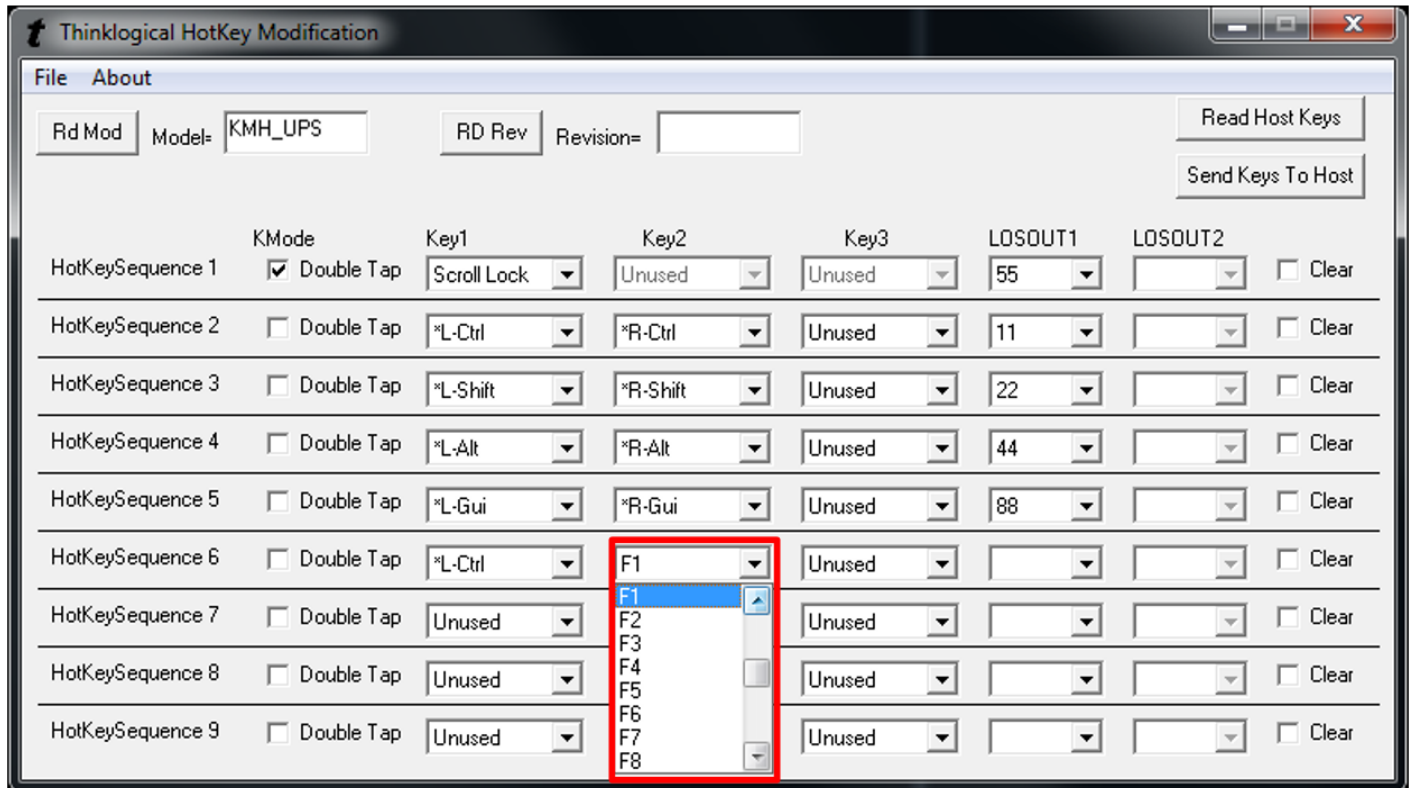

By left-clicking on the **LOSOUT1 drop-down menu**, users can select from a list of hex values, so that pressing *L-Ctrl* and *F1* will execute the function associated with that value.

Users can also enter a non-hex value by scrolling to the bottom of the list and clicking on *Spec1*.

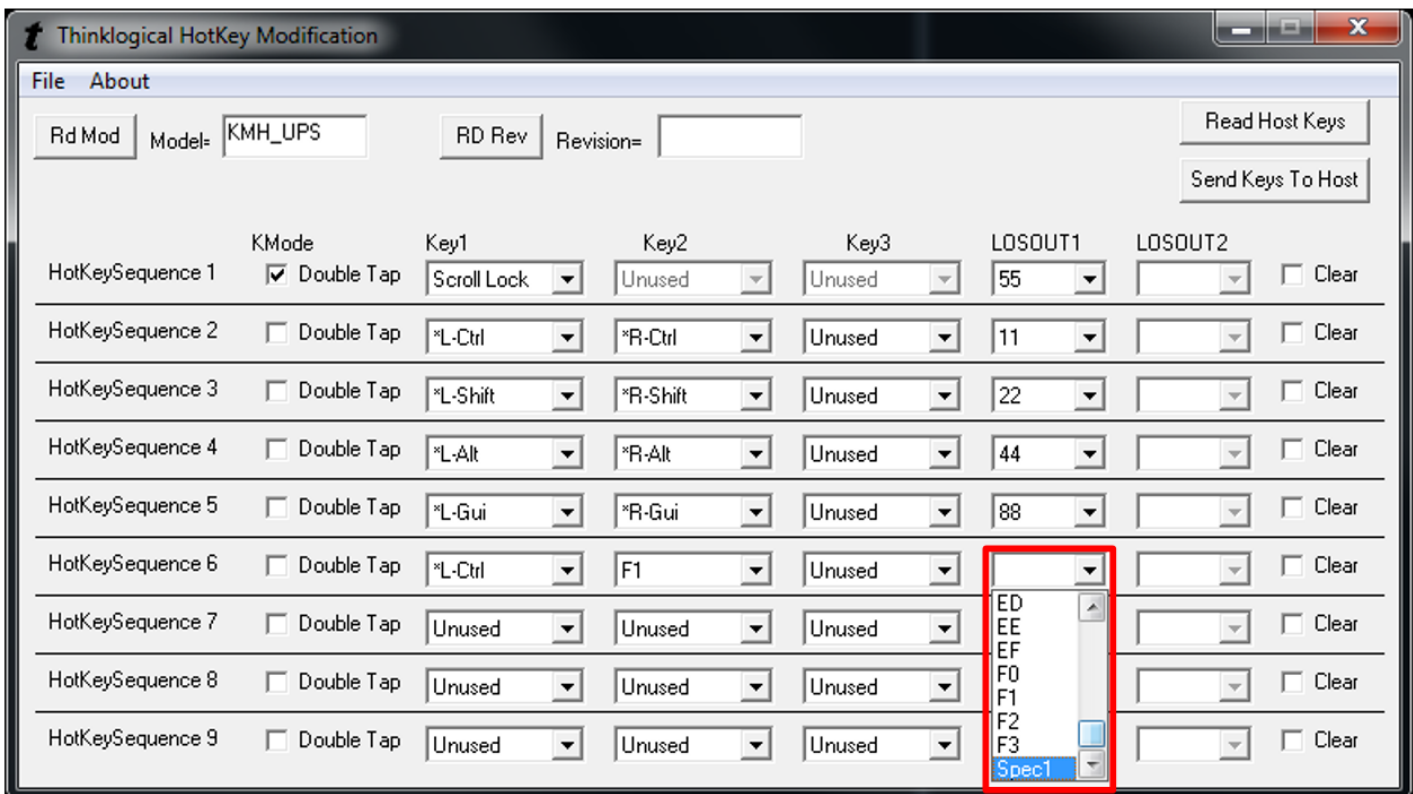

By selecting *Spec1*, the value in LOSOUT2 will automatically become *Rd Kb* (Read Keyboard), meaning it will “read” the next thing typed. **The user must now enter a non-hex numerical value, which will become an action associated with L-Ctrl and F1.** To clear the entries, click in the *Clear* box to the right.

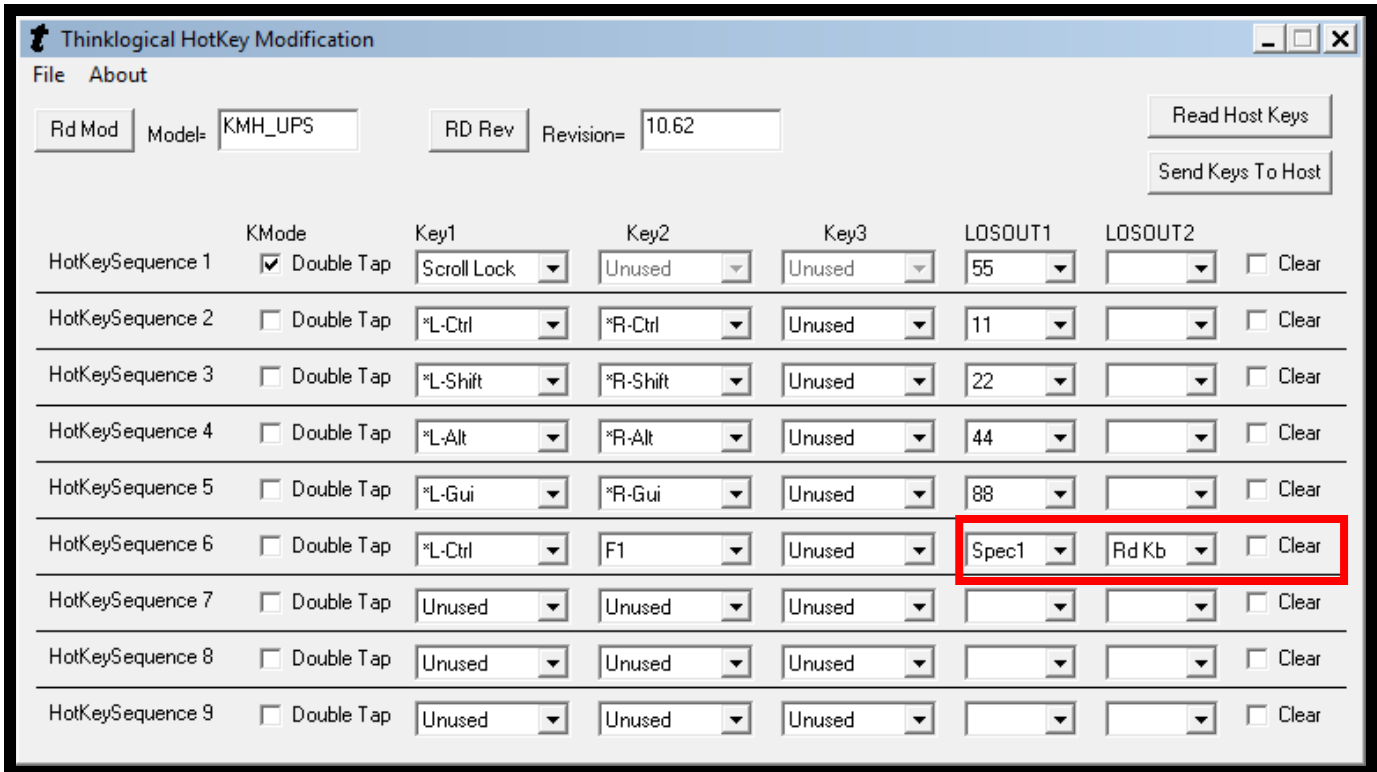

For **Q-Series Systems**, connect to the Q4300/4200 chassis via the front panel Update port. A *Select Card* box allows changes to a specific module in one of the four available card slots.

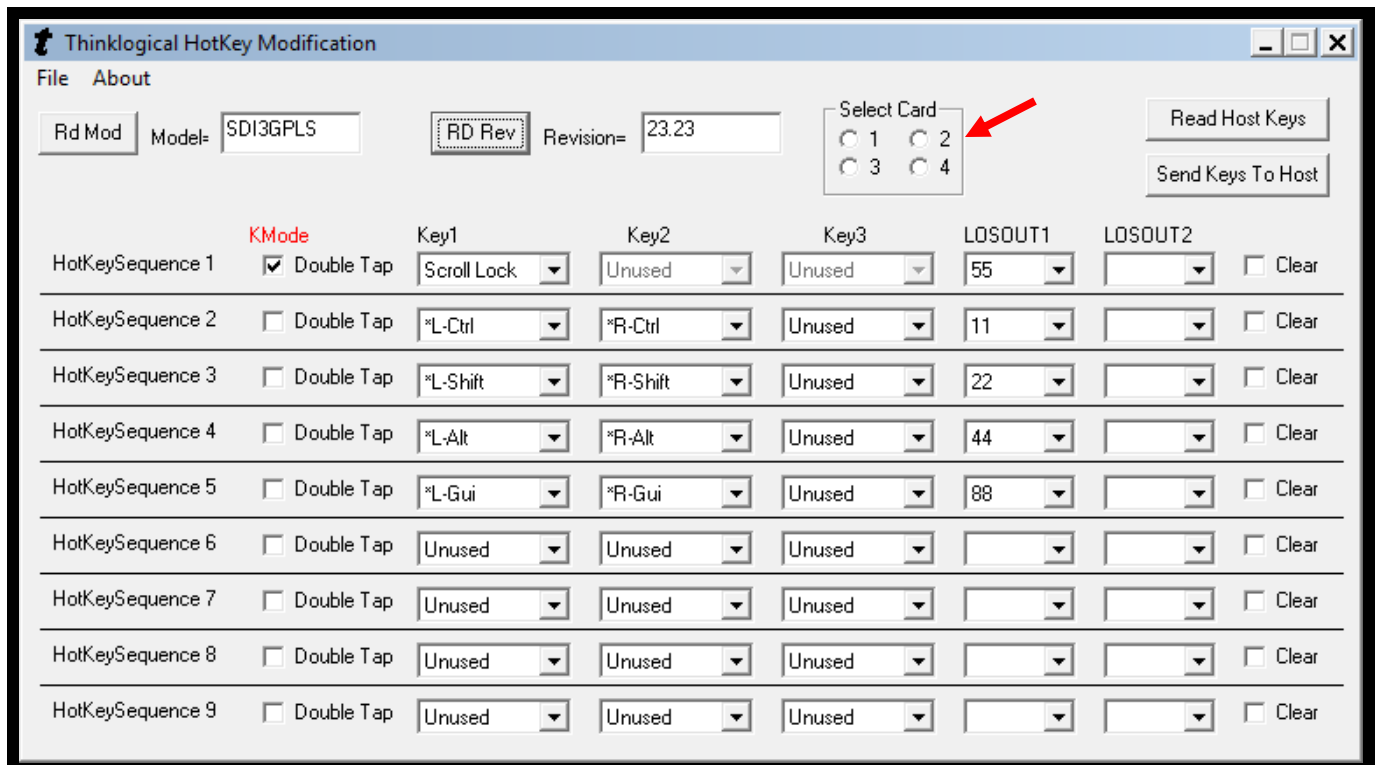

Below are the default Hotkeys programmed into TLX Receivers:

The screenshot shows the 'Thinklogical HotKey Modification' application window. At the top, there are fields for 'Rd Mod' (Model: SDI3GPLS), 'RD Rev' (Revision: 23.27), and a 'Select Card' dropdown (set to 4). There are also 'Read Host Keys' and 'Send Keys To Host' buttons. Below this is a table of hotkey sequences:

HotKeySequence	KMode	Key1	Key2	Key3	LOSDOUT1	LOSDOUT2	Clear
HotKeySequence 1	<input checked="" type="checkbox"/> Double Tap	Scroll Lock	Unused	Unused	55		<input type="checkbox"/>
HotKeySequence 2	<input type="checkbox"/> Double Tap	*L-Ctrl	*R-Ctrl	Unused	11		<input type="checkbox"/>
HotKeySequence 3	<input type="checkbox"/> Double Tap	*L-Shift	*R-Shift	Unused	22		<input type="checkbox"/>
HotKeySequence 4	<input type="checkbox"/> Double Tap	*L-Alt	*R-Alt	Unused	44		<input type="checkbox"/>
HotKeySequence 5	<input type="checkbox"/> Double Tap	*L-Shift	F1	Unused	81		<input type="checkbox"/>
HotKeySequence 6	<input type="checkbox"/> Double Tap	*L-Shift	F2	Unused	82		<input type="checkbox"/>
HotKeySequence 7	<input type="checkbox"/> Double Tap	*L-Shift	F3	Unused	83		<input type="checkbox"/>
HotKeySequence 8	<input type="checkbox"/> Double Tap	*L-Shift	F4	Unused	84		<input type="checkbox"/>
HotKeySequence 9	<input checked="" type="checkbox"/> Double Tap	*R-Ctrl	Unused	Unused	Spec1	Rd Kb	<input type="checkbox"/>

TECH NOTES: *Programming Many Receiver Modules*

If it is necessary to program many receiver modules, it is possible to save a set of Flexkeys in a file on your PC. This file can then be downloaded to as many receivers as required. These operations are located under the File menu as shown.

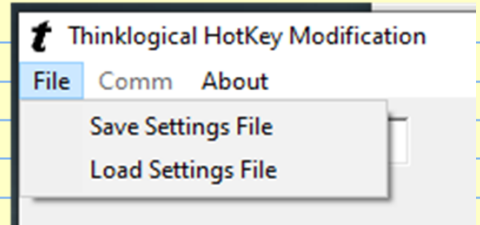

Appendix F: SMP3 Redundancy

There is typically only one SMP Appliance or SMP Module controlling the system, which may also be in conjunction with a third-party control system. However, it is possible for two SMP Appliances or Modules to be installed and configured in a redundant fashion as Primary and Backup units. In this case, the Backup SMP Appliance or Module will take control of the system if the Primary SMP Appliance or Module should fail.

There are preliminary steps in setting up SMP3 Redundancy. For details on the installed Linux version, see: /usr/lib/os-release.

For Ubuntu versions:

Installing SYNC

- Connect the Matrix Switch and both SMP3 units to the same network, but with different static IP addresses (configured previously).
- On the Primary SMP3 unit:
 - Open a terminal window, login as **root**.
 - Navigate to `/opt/tl/pkg`. (see note below)
 - Unpack the install files: **tar -xvzf sync_install_010106.tgz**
 - Change directories: **cd sync**
 - Install the package: **sh sync_install.sh [backup IP address]**
- On the Backup SMP3 unit:
 - Open a terminal window, login as **root**.
 - Navigate to `/opt/tl/pkg`. (see note below)
 - Unpack the install files: **tar -xvzf sync_install_010106.tgz**
 - Change directories: **cd sync**
 - Install the package: **sh sync_install.sh [primary IP address]**
- On the Primary SMP3:
 - Install the package again: **sh sync_install.sh [backup IP address]**
- SYNC is now installed and running on both units.



Note: During the installation of the SYNC application, you will be prompted for the password of the “user” account of the companion (other) machine.

For CentOS versions:

Installing SYNC

- Connect the Matrix Switch and both SMP3 units to the same network, but with different static IP addresses (configured previously).
- On the Primary SMP3:
 - Open a terminal window, login as **root**.
 - Navigate to `/home/user/pkg`.
 - Unpack the install files: **tar -xvzf sync_install_010005e.tgz**
 - Change directories: **cd sync**
 - Install the package: **sh sync_install.sh [backup IP address]**
 - The administrator must enter the default password **think1**

- On the Secondary SMP3 unit:
 - Open a terminal window, login as **root**.
 - Navigate to `/home/user/pkg`.
 - Unpack the install files: `tar -xvzf sync_install_01005e.tgz`
 - Change directories: `cd sync`
 - Install the package: `sh sync_install.sh [primary IP address]`
 - The administrator must enter the default password **think1**
- On the Primary SMP3:
 - Install the package again: `sh sync_install.sh [backup IP address]`
- SYNC is now installed and running on both units.



Note: During the installation of the SYNC application for CentOS, a 'think1' user is created with the password 'think1.' For security, it is recommended that this password be deleted by running the command 'passwd -d think1' at the Linux prompt. Delete the password, not the account. (Account is for internal use only.)

Configuring the SMP3 units – Use ADM for this step

If available, install the desired SMP3 configuration files on the Primary SMP3 unit. If not completed, they can be installed later.

For this example, we have chosen:

- IP address 192.168.13.9 as the virtual IP address.
- IP address 192.168.13.10 as the Primary IP address.
- IP address 192.168.13.11 as the Secondary IP address.

Configure the Primary SMP3 as shown:

APPLIANCE	ACTIVE	
REDUNDANCY	<input checked="" type="radio"/> ENABLE	
VIRTUAL IP ADDRESS	192.168.13.9	← Virtual IP Address of the SMP pair. This address will be used when configuring the Matrix Switch
VIRTUAL IP DEVICE	ETH0	
SMP SERVER	PRIMARY <input checked="" type="radio"/> BACKUP <input type="radio"/>	← Primary is selected.
INTERFACE	ETH0 <input checked="" type="radio"/> ETH1 <input type="radio"/>	
SMP MTX (VIRTUALS) to PING	192.168.13.15	← Address from the SMP3 MTX tab.
SMP MTX (BACKUPS) to PING	192.168.13.115	← Enter address of the matrix Backup controller card.
STATUS : REDUNDANCY	ACTIVE	
STATUS : SMP SERVICE	ACTIVE	
APPLY		
SYNC FROM IP ADDRESS	192.168.13.11	← Physical address of Backup SMP
SYNC	<input checked="" type="radio"/> SYNC NOW	
	<input type="radio"/> AUTO	
	MINUTES	

Primary ADM REDUNDANCY Tab

Configure the Backup SMP3 as shown:

APPLIANCE	STANDBY
REDUNDANCY	<input checked="" type="radio"/> ENABLE
VIRTUAL IP ADDRESS	192.168.13.9
VIRTUAL IP DEVICE	ETH0
SMP SERVER	PRIMARY <input type="radio"/> <input checked="" type="radio"/> BACKUP
INTERFACE	ETH0 <input checked="" type="radio"/> <input type="radio"/> ETH1
SMP MTX (VIRTUALS) to PING	192.168.13.15
SMP MTX (BACKUPS) to PING	
STATUS : REDUNDANCY	ACTIVE
STATUS : SMP SERVICE	ACTIVE
<input type="button" value="APPLY"/>	
SYNC FROM IP ADDRESS	192.168.13.10
<input type="button" value="SYNC NOW"/>	
SYNC	<input type="radio"/> AUTO
	MINUTES
<input type="button" value="APPLY"/>	

Backup is selected.

Physical address of Primary SMP

Backup ADM REDUNDANCY Tab



Note: The above example is for an SMP Appliance that has eth0 and eth1 interfaces. An SMP Module or SMP/ICT has only eth0.



Warning! If an SMP3 Appliance or SMP3 Module is configured and running and then a Backup is added, do NOT sync the Primary from the Backup. The configuration may be lost if the Backup configuration is not current. It is preferable to perform configuration updates on the Primary SMP, then Sync the Backup SMP from the Primary. A warning popup will be displayed reminding Admins of this.



Warning! If a redundant SMP3 Appliance or SMP3 Module is added to an existing running system, it is recommended this be done by trained and experienced personnel.

Testing Redundancy:

To test your Redundancy setup, click **APPLY** on the SMP3 unit that is currently active. This will temporarily stop the SMP3 service and the other SMP3 unit will take over.

Alternatively, removing the network cable from the Active SMP will fail over to the other SMP.

Example: Fully Redundant System Configuration



APPLIANCE	ACTIVE
REDUNDANCY	<input checked="" type="radio"/> ENABLE
VIRTUAL IP ADDRESS	192.168.13.9
VIRTUAL IP DEVICE	ETH0
SMP SERVER	<input checked="" type="radio"/> PRIMARY <input type="radio"/> BACKUP
INTERFACE	ETH0 <input type="radio"/> ETH1
SMP MTX (VIRTUALS) to PING	192.168.13.15
SMP MTX (BACKUPS) to PING	
STATUS : REDUNDANCY	ACTIVE
STATUS : SMP SERVICE	ACTIVE
<input type="button" value="APPLY"/>	
SYNC FROM IP ADDRESS	
SYNC	<input checked="" type="radio"/> SYNC NOW <input type="radio"/> AUTO
	MINUTES
<input type="button" value="APPLY"/>	

APPLIANCE	STANDBY
REDUNDANCY	<input checked="" type="radio"/> ENABLE
VIRTUAL IP ADDRESS	192.168.13.9
VIRTUAL IP DEVICE	ETH0
SMP SERVER	<input type="radio"/> PRIMARY <input checked="" type="radio"/> BACKUP
INTERFACE	ETH0 <input checked="" type="radio"/> ETH1
SMP MTX (VIRTUALS) to PING	192.168.13.15
SMP MTX (BACKUPS) to PING	
STATUS : REDUNDANCY	ACTIVE
STATUS : SMP SERVICE	ACTIVE
<input type="button" value="APPLY"/>	
SYNC FROM IP ADDRESS	
SYNC	<input checked="" type="radio"/> SYNC NOW <input type="radio"/> AUTO
	MINUTES
<input type="button" value="APPLY"/>	

Appendix G: Protocols and Port Numbers

This figure is for the use of network administrators in a **secure computing environment**. It illustrates the protocols and port numbers used in Thinklogical systems. Also available under the GUIDE Tab.

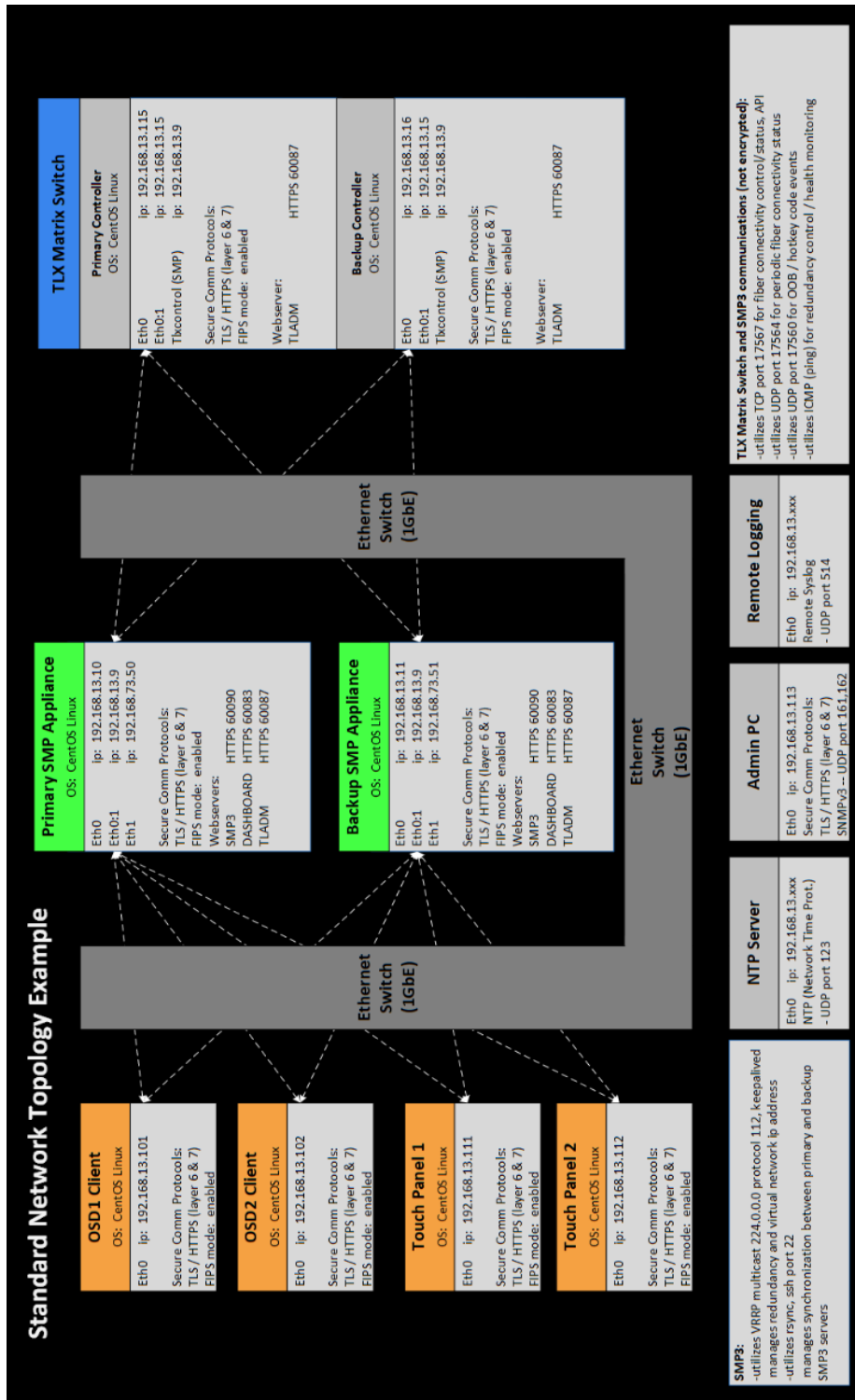

Appendix H: Intuitive Mouse Setup

If the Intuitive Mouse feature is being setup in the system, it must first be configured in the SMP3 as described in the Hot Keys section. The extenders must also have this feature enabled.

Hardware Settings:

- On the chassis LCD supporting an Intuitive-Mouse-capable Transmitter, the **MS Screen Select** must be set to **YES**. This lets the computer know that it should use *Absolute Position* for the mouse.

MS Screen Select
Yes/No YES

-OR-

Mouse Screen Select
Yes/No YES

- On an Intuitive-Mouse-capable Receiver, **MsScrn Sel Disable** must be set to **NO**.

MsScrn Sel Disable
Yes/No NO

-OR-

Intuitive Mouse
Mode = Enabled

- On an Intuitive-Mouse-capable Receiver, **Allow Out of Band?** must be set to **Y**.

Allow Out of Band?
Yes/No Y



Note: All TLX Extenders support Intuitive Mouse, as do some Velocity extenders, such as the VQM-HA0006-LCRX.

- Extenders support Intuitive Mouse at the HID ports, not the USB 2.0 ports.
- The back channel is required for Intuitive Mouse; (both fibers connected).

Software Configuration:

Each keyboard requiring INT Mouse must have a Hotkey created. This is done in the SMP3 application ADMIN/HOTKEYS tabs as shown below. This example is for two monitors mounted side by side.

- Add a new line for the hotkey and select the keyboard.
- Select "INT MOUSE" in the Action column. The Code column will autofill with "INT."
- Monitors must now be defined in the Action column. They must be in the same order as they are installed at the desk.
- Left click on the ellipsis (...) and a menu will pop up that includes provisions for monitor and row selection.

Code Defaults	Key Combo	CTRL + CTRL	SHIFT + SHIFT	ALT + ALT	SCROLL (twice)
	Code	11	22	44	55
Origin	Code	Action			
*	55	OSD, 1			
*	88	TOGGLE, ...			
Kbd 1	11	SHARE CYCLE, WS-1.1, Mac-1, NUC-1, Tower-1 HD1, ..			
Kbd 1	22	TAKE CYCLE, WS-1.1, NUC-1, ...			
Kbd 1	44	CONNECT, Tower-1 HD1, WS-1.1, ...			
Kbd 1	89	TAKE CYCLE, WS-1.1, Mac-1, ...			
Kbd 2	INT	INT MOUSE, WS-2.1, WS-2.2 ...			

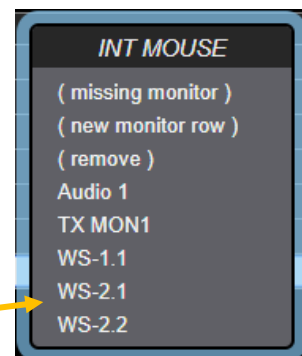

Appendix I: “Persistent” Feature

There may be a need to have what is called a “Persistent connection” which would apply to CACs, PIV, PKI, Audio, or other functions (including video). This requires a column name preceded by a “!”.

Standard

In a standard configuration, Sources may have blank assignments for ports that are not needed. Then if a new Source with a blank cell is routed to a Destination that has something already routed to it; the previous Source is disconnected.

Example:

<i>Src Name</i>	<i>Vid(R)</i>	<i>Vid2(R)</i>
PC1	A__1	A__2
PC2	A__3	
<i>Dst Name</i>	<i>Vid(T)</i>	<i>Vid2(T)</i>
Desk1	A__4	A__5

Operation:

1. PC1 is routed to Desk 1; A__1 is connected to A__4 and A__2 is connected to A__5.
2. Then PC2 is routed to Desk 1; A__3 is connected to A__4 and A__5 is disconnected.

Persistent

However, the SMP3 can be configured with the Persistent feature. In this case the Persistent connection will remain while the user routes a different Source with a blank port assignment.

Example:

<i>Src Name</i>	<i>Vid(R)</i>	<i>!Vid2(R)</i>
PC1	A__1	A__2
PC2	A__3	
<i>Dst Name</i>	<i>Vid(T)</i>	<i>!Vid2(T)</i>
Desk1	A__4	A__5

Operation:

1. PC1 is routed to Desk 1; A__1 is connected to A__4 and A__2 is connected to A__5.
2. Then PC2 is routed to Desk 1; A__3 is connected to A__4 and A__2 stays connected to A__5.

Typical use case

- A User routes a Source with a CAC attached to it to one of their monitors.
- The User then accesses a different Source that does not have a CAC.
- The CAC connection remains in place.
- The User then returns to the original Source.
- The User does not have to log in again to that Source since the CAC connection was not broken.

Persistent connections can be disconnected in one of two ways:

1. Intentionally Clear the connection.
2. Route another Persistent Source to that Destination.

Typical configuration

Note that this feature is not included in the factory default SMP3 configuration. The appropriate columns need to be added to the Sources and Destination areas of the stations.csv file. Persistent columns are preceded by a “!” sign.

Notes:

- Adjacent new columns must have unique names. In this example they are “USBd” and USBs.”
- The Source and Destination column names must match up with each other, with the exception of the “T” and “R” designation. In this example “USBd(T)” lines up with “USBd(R)”, and “USBs(R)” lines up with “USBs(T)”

<i>Src Name</i>	<i>Follows</i>	<i>Primary</i>	<i>VidA(R)</i>	<i>VidB(R)</i>	<i>Kbd(T)</i>	<i>Kbs(R)</i>	<i>Aud(R)</i>	<i>!USBd(T)</i>	<i>!USBs(R)</i>
ALPHA			A_1	A_2	A_1	A_1	A_1		
BRAVO			A_3	A_4	A_3	A_3	A_3		
CHARLIE			A_5	A_6	A_5	A_5	A_5		

Standard

Persistent

<i>Dst Name</i>	<i>Follows</i>	<i>VidA(T)</i>	<i>VidB(T)</i>	<i>Aud(T)</i>	<i>!USBd(R)</i>	<i>!USBs(T)</i>
DESK 1-1		A_35	A_36			
DESK 1-2	DESK 1-1	A_37	A_38			

Appendix J: SMP3 API (v.19)

Thinklogical's SMP3 API is an ASCII based control interface available to interactive users and third party controller systems.

Commands (and responses) have historically been started and finished with parentheses. While the examples herein still show the commands formatted this way, parentheses are now optional.

Two (or more) commands can be sent at one time by separating them with linefeeds (\n).

The commands and responses are string fields separated by spaces. Field identifiers begin with colons (':') and the strings they identify follow immediately after and must be enclosed with double quotes (") if the string in question includes spaces or optionally for strings without spaces. Asterisks can be quoted or left unquoted as a matter of preference.

For example, the command to connect the destination named "Dst 1" from the source named "Src A" with permissions tested for "Bob" is as follows: (dstExe "Dst 1" :sname "Src A" :user "Bob")

The first field in every statement is normally a conjunction of the object type being acted upon and the action to be performed. In this case it is a destination ("dst") and execution ("Exe").

The second field is the object of the command or description. Since the command in this case is dstExe, the next field should be a string with the name of the destination: "Dst 1".

The remaining fields are strings of information required for the operation or description of the related object.

In this example, (dstExe "Dst 1" :sname "Src A" :user "Bob"), there is an identifier :sname (for source name), and "Src A" (the name of the source) and "Bob" the user who's requesting the action. This command means "dstExe" (execute for the destination named) "Dst 1" by setting the source (:sname) to "Src A" (or more simply, connect "Dst 1" from "Src A"). If Bob has permission to access the source and destination, then the action will be performed.

The responses to this command are similarly formatted:

```
(dstSta "Dst 1" :sname "Src A")
(srcSta "Src A" :dnames ["Dst 1"])
```

Note: When aliases are defined for the destination and/or source, the result can look like this:

```
(dstSta "Dst 1" :dalias "News Desk" :sname "Src A" :salias "Camera 3")
```

It is important to note that the automatic status response to a command (in this case "dstSta" as a response to "dstExe") only includes information that has changed *because* of the command. It is a status *update*, not a complete listing of the status for the object in question. This will be important when we consider other fields like :control and :lockBy as shown below. If required, the complete status must be requested explicitly.

In addition, the API will push status updates to the client even when the command(s) that caused the updates originated from other sources like web or other API clients.

Finally, other controllers (AMX, Crestron) may be sending commands *directly to the matrix* that can cause status changes, and these will also be pushed to the web and API clients. An API client needs to be ready to receive status updates even when it is not actively sending commands.

Configuration and Control

To use the API, SMP3 must be configured with a user named “api”. Details are not important as it is only used to turn the API on/off and will have all the rights of the admin user.



Login

The API is accessed via socket at port 60092.

On connection, the API will send “*user: ?*” as a prompt. The client should send “*user: admin*” terminated with a linefeed (“\n”) and the API will respond with “*challenge: <32 hex digit random string or ‘salt’>*”.

In order to avoid passwords saved in plain text, they are “hashed” with “SHA1” and saved. But sending the same hashed password across the network every time is easy to sniff, so the hashed passwords are “salted” with a random string of the server’s choosing before being transmitted to the server.

So when the API presents a challenge to the client, the client should:

- hash the real password
- append the challenge/salt string to the hashed password
- hash the resultant string
- and send the return string as “*response: < hash(hash(password) + salt) > + ‘\n’*”

If the response matches the string the server is expecting, the server will send “*auth: pass*” and accept commands.

If the response does not match the string the server is expecting, it will respond with “*auth: fail*” and a new challenge.

Here is an example login interchange with the first attempt unsuccessful followed by success. (Server lines are in *light gray italics*.)

```
user: ?
user: admin
challenge: b6988e8d0b099c2f67646b69c385ffd5
response: abc
auth: fail
challenge: 19d48c9f79394c5a72161687ea10bee9
response: 61588274600859e8941452a448f95937360789da
auth: pass
```

Explanation: In the preceding example, the admin password is “admin”. The SHA1 hash of “admin” is “d033e22ae348aeb5660fc2140aec35850c4da997”.

```
hash(admin) + challenge =
“d033e22ae348aeb5660fc2140aec35850c4da99719d48c9f79394c5a72161687ea10bee9”
```

The resulting SHA1 hash of that is: “61588274600859e8941452a448f95937360789da”. This is the string the server is expecting for the admin account and the given challenge/hash.

After a successful response, the server is ready to handle commands.

The command string “logout” will immediately terminate the session and connection.

Challenge/Response Example

Here is an example demonstrating the challenge/response process from a Linux command line.

Assume that the password for username 'admin' is 'admin'.

First hash the password --

```
$ echo -n 'admin' | sha1sum
```

```
d033e22ae348aeb5660fc2140aec35850c4da997 - (this is hash('admin'))
```

Now combine the hash('admin') result with the challenge as shown in previous page (the challenge is in blue to better illustrate how the two strings are combined) –

```
$ echo -n d033e22ae348aeb5660fc2140aec35850c4da99719d48c9f79394c5a72161687ea10bee9 | sha1sum
```

```
61588274600859e8941452a448f95937360789da –
```

This last number is the correct response for password: admin
and challenge: *19d48c9f79394c5a72161687ea10bee9*

Users

It is also possible to take advantage of SMP user access management configuration.

Previous commands, with no user designation, are treated as though the “admin” account is sending them.

But if a command includes a `:user <user>` phrase, the command will be only executed if the named user exists and has the access rights to perform the command.

Furthermore, when pool reservations are made the command should be tagged with `:user <username>` so the ownership of the reserved source is associated with the user who requested it. This will be covered in more detail in the commands regarding Pools later in this document.

In the following examples and descriptions, the `:user` field is always included for consistency. However, since the API is running as admin, if the `:user` field is omitted the command will be run as admin.

Example API Session

To access the SMP3 API ASCII based control interface: “telnet <ip address> 60092”

In this, operator input is shown with a blank line preceding it. This is for illustration purposes only and is not the case during runtime.

```
1 [alexh]$ telnet 10.0.0.134 60092
2 Trying 10.0.0.134...
3 Connected to 10.0.0.134.
4 Escape character is '^'.
5 user: ?
6
7 user: admin
8 challenge: fd395b8b5e8fbed52e6b5e9d7580c337
9
10 response: 92b8d86f223f20177faa1707cfc75cd1f5d12af4
11 pass
12
13 (dstSta? "*" :user "admin")
14
15 (dstExe "DESK.3.MON.1" :sname "PC_A" :user "Bob")
16 (dstSta "DESK.3.MON.1" :sname "PC_A" :salias "PC<br>A")
17 (srcSta "PC_A" :dnames ["DESK.3.MON.1"])
18
19 (dstExe "DESK.3.MON.1" :control "PC_A" :user "Bob")
20 (kbdSta "DESK.3.HID" :sname "PC_A" :dname "DESK.3.MON.1")
21 (srcSta "PC_A" :dnames ["DESK.3.HID","DESK.3.MON.1"] :control "DESK.3.HID")
22
23 (dstExe "DESK.3.MON.1" :sname "" :user "Bob")
24 (kbdSta "DESK.3.HID" :sname "" :dname "")
25 (dstSta "DESK.3.MON.1" :sname "")
26
27 (dstSta? "DESK.3.MON.1" :user "Bob")
28 (dstSta "DESK.3.MON.1" :sname "")
29
30 (dstSta? "*" :user "admin")
31
32 logout
33 Connection closed by foreign host.
34 [alexh]$
35
```

*Note: As shown above, when “dstSta? *” is executed and there are no connections, the API will return nothing.

Commands and Responses

Communications Test: (ping? "*")

Example: (ping? "*")

Translation: is this socket connection active?

Response: (pong "*")

Connect: (dstExe <destination> :sname <source> :user <user>)

Example: (dstExe "Dst 1" :sname "Src A" :user "Bob")

Translation: connect "Src A" to "Dst 1" if user Bob has the necessary permissions. If the user is not specified, then the action will be performed as though requested by the admin user.

Responses: (dstSta "Dst 1" :sname "Src A")

(srcSta "Src A" :dnames ["DST 1"] :control "")

**Note:* The responses may be sent more than once.

Connect keyboard: (dstExe <destination> :control <source> :user <user>)

Example: (dstExe "Dst 1" :control "Src A" :user "Bob")

Translation: Connect the keyboard at "Dst 1" to "Src A" if user Bob has the necessary permissions.

Responses: (kbdSta "Dst 1-Kbd" :sname "Src A" :dname "Dst 1")

(srcSta "Src A" :dnames ["Dst 1-Kbd", "Dst 1"] :control "Dst 1-Kbd")

**Note:* kbdSta (keyboard status) will show as its object the keyboard associated with the destination(s). A single keyboard may serve multiple destinations so it needs to show which destination's source is being controlled. This association is set and described in the "ADMIN / DST" and "ADMIN / KBD" pages.

**Note:* In order to avoid controlling the wrong source, the source must first be present at the destination video before the keyboard can be connected. In practice, this usually requires connecting the video about 300 ms before connecting the keyboard.

Disconnect destination: (dstExe <destination> :sname "" :user <user>)

Example: (dstExe "Dst 1" :sname "" :user "Bob")

Translation: Disconnect "Dst 1"

Response: (dstSta "Dst 1" :sname "")

**Note:* If the keyboard assigned to this destination was controlling a source, then it will also send a response showing the keyboard status has changed:

Responses: (kbdSta "Dst 1-Kbd" :sname "" :dname "")

(dstSta "Dst 1" :sname "")

Disconnect keyboard: (dstExe <destination> :control "" :user <user>)

Example: (dstExe "Dst 1" :control "" :user "Bob")

Translation: Disconnect "Dst 1" keyboard

Response: (kbdSta "Dst 1-Kbd" :sname "" :dname "")

Lock a destination: (dstExe <destination> :lockBy <user> :user <user>)

Example: (dstExe "Dst 1" :lockBy "Carol" :user "Carol")

Translation: API is locking Dst 1

Response: (dstSta "Dst 1" :lockBy "Carol")

Request destination status: (dstSta? <destination> :user <user>)

Example: (dstSta? "Dst 1" :user "Bob")

Translation: Request status of "Dst 1"

Response: (dstSta "Dst 1" :sname "Src A" :lockBy "Carol")

**Note:* If the source at this destination has an alias, it will appear after the identifier ":salias".

Unlock a destination: (dstExe <destination> :lockBy false :user <user>)

Example: (dstExe "Dst 1" :lockBy false :user "Carol")

Translation: "Dst 1" is being unlocked

Response: (dstSta "Dst 1" :lockBy false)

**Note:* the destination can only be unlocked by the user who locked it or admin.

If the API is attempting to unlock a destination locked by another user, the response will show the destination still locked as shown below

Example: (dstExe "Dst 1" :lockBy false :user "Bob")

Response: (errSta "Dst 1" :msg "Dst 1 must first be unlocked by Carol")

Request source status: (srcSta? <source> :user <user>)

Example: (srcSta? "Src A" :user "admin")

Translation: Request complete status of Src A

Response: (srcSta "Src A" :dnames ["Dst 1", "Dst 2"] :control "Kbd 1")

**Note:* As shown, the associated value for the identifier/key "dnames" is a list which starts with '[' and ends with a right ']'.

Request source status for all connected or locked sources: (srcSta? "*" :user "admin")

Example: (srcSta? "*" :user "admin")

Translation: Request complete status of all sources connected or locked

Response(s):

(srcSta "Src A" :dnames ["Dst 1", "Dst 2"] :control "Kbd 1")

(srcSta "Src B" :dnames [] :lockBy "Bob")

Request source status for all sources: (srcDef? "*" :user "admin")

Example: (srcDef? "*" :user "admin")

Translation: Request complete status of all sources

Response(s):

(srcSta "Src A" :dnames ["Dst 1", "Dst 2"] :control "Dst 1")

(srcSta "Src B" :dnames [] :lockBy "Bob")

(srcSta "Src C" :dnames ["Dst 7"] :control "")

...

Request destination definition and status for all destinations and keyboards: (dstDef? "*" :user "admin")

Example: (dstDef? "*" :user "admin")

Translation: Request complete definition of all destinations, and status of all destinations and keyboards

Response(s):

(dstDef "DESK.1.MON.1" :dalias "DESK 1
1")

(dstDef "DESK.1.MON.2" :dalias "DESK 1
2")

...

(dstSta "DESK.1.MON.1" :sname "Src A")

(kbdSta "DESK.1.HID.1" :sname "Src A" :dname "DESK.1.MON.1")

(dstSta "DESK.1.MON.2" :sname "")

...

Lock source: (srcExe <source> :lockBy <user> :user <user>)

Example: (srcExe "Src A" :lockBy "Carol" :user "Carol")

Translation: Carol is locking "Src A" so it cannot be used anywhere else

Response: (srcSta "Src A" :lockBy "Carol")

**Note:* Requests for "Src A" will also include the lockBy if it is not false, as in:

(srcSta "Src A" :dnames ["Dst 1", "Dst 2"] :control "Dst 1" :lockBy "Carol")

Unlock source: (srcExe <source> :lockBy false :user <user>)

Example: (srcExe "Src A" :lockBy false :user "Bob")

Translation: "Src A" is being unlocked

Response: (srcSta "Src A" :lockBy false)

Disconnect a source from all destinations: (srcExe <source> :dname "" :user <user>)

Example: (srcExe "Src A" :dname "" :user "Bob")

Translation: Disconnect "Src A" from all destinations

Response (assuming "Src A" was previously connected to "Dst 1" and "Dst 2" and controlled by "Dst 1-Kbd"):

(dstSta "Dst 1" :sname "")

(dstSta "Dst 2" :sname "")

(kbdSta "Dst 1-Kbd" :dname "")

Execute a macro: (macExe <macro> :user <user>)

Example: (macExe "Start Up" :user "Bob")

Translation: Execute the macro named "Start Up"

Response(s):

(dstSta "Dst 1" :sname "Src A")

(dstSta "Dst 2" :sname "Src B")

(dstSta "Dst 3" :sname "Src C")

(dstSta "Dst 4" :sname "Src D")

(kbdSta "Dst 1" :dname "Dst 1")

*Note: As shown, there may be many responses to a single macro, depending on the number of steps.

Unsolicited Notices

A source has had its Alias changed:*Notice(s):*

```
(srcDef "PC1" :Alias "PC<br>Prime")
```

```
(srcSta "PC1")
```

A source's name has been changed:*Notice(s):*

```
(srcDef "PC1" :Src Name "PC0001" :Alias "PC<br>Prime")
```

```
(srcSta "PC0001")
```

Pool Related Functions

Request pool definitions and sources allocated to the pools: (poolDef? <pool> :user <user>)

Example: (poolDef? "*" :user "admin")

Translation: Request pool definitions for all pools

Responses (assuming there are two pools, "Pool_M" and "Pool_S"):

(poolDef "Pool_M" :srcs ["Src_1","Src_2","Src_3"])

(poolDef "Pool_S" :srcs ["Src_4","Src_5","Src_6"])

Note: poolDef should be used by admin and not by other users.

Pool_M has three (3) sources with their names in the list after :srcs

Pool_S also has three (3) sources with their names in the list after :srcs

Reserve a source from a pool: (userExe <user> :reserve <pool> :user <user>)

Example: (userExe "Bob" :reserve "Pool_S" :user "Bob")

Translation: Request a source from pool "Pool_M" for user "Bob" if Bob has access to "Pool_S". If the :user "Bob" phrase is not included, then the action will be performed as though the admin account requested it.

Responses (assuming Bob has rights to pool Pool_M and there are unreserved sources available in Pool_M):

(poolSta "Pool_M" :reserved [] :avail true)

(poolSta "Pool_S" :reserved ["Src_6"] :avail true)

(userSta "Bob" :reserved [["Pool_S","Src_6"]])

Note: (poolSta "Pool_S" :reserved ["Src_6"] :avail true)

indicates that "Src_6" has been reserved from "Pool_S" and there are still additional sources from "Pool_S" available. It is also important to note that the API may respond with a list of **all** the pools and their reservations and availability even if the reserve action did not involve them.

(userSta "Bob" :reserved [...])

is a list of [poolname, source] pairs currently reserved to Bob.

Reserve a specific source from a pool: (userExe <user> :reserve <pool> :sname <source> :user <user>)

Example: (userExe "Bob" :reserve "Pool_S" :sname "Src_3" :user "Bob")

Translation: Request a specific source named "Src_3" from pool "Pool_M" for user "Bob" if Bob has access to "Pool_S". If the :user "Bob" phrase is not included, then the action will be performed as though the admin account requested it.

Responses (assuming Bob has rights to pool Pool_M and there are unreserved sources available in Pool_M):

(poolSta "Pool_M" :reserved [] :avail true)

(poolSta "Pool_S" :reserved ["Src_3"] :avail true)

(userSta "Bob" :reserved [["Pool_S","Src_3"]])

Note: (poolSta "Pool_S" :reserved ["Src_6"] :avail true)

indicates that "Src_6" has been reserved from "Pool_S" and there are still additional sources from "Pool_S" available. It is also important to note that the API may respond with a list of **all** the pools and their reservations and availability even if the reserve action did not involve them.

(userSta "Bob" :reserved [...])

is a list of [poolname, source] pairs currently reserved to Bob.

Request a list of reserved sources and pool availability for all pools: (poolSta? "*" :user <user>)

Example: (poolSta? "*" :user "Bob")

Translation: Request pool status of all pools

Responses (if there are two (2) pools):

(poolSta "Pool_M" :reserved [] :avail true)

(poolSta "Pool_S" :reserved ["Src_6"] :avail true)

Note: poolSta "*" when :user is admin will return the status of all the pools.

poolSta "*" when :user is not admin only returns status for the pools to which the user has access.

Request list of reserved sources and availability for a pool: (poolSta? <pool> :user <user>)

Example: (poolSta? "Pool_S" :user "Bob")

Translation: Request pool status of Pool_S

Response: (poolSta "Pool_S" :reserved ["Src_6"] :avail true)

Release a reserved source back to the pool from which it was reserved:

(userExe <user> :release <source> :user <user>)

Example: (userExe "Bob" :release "Src_6" :user "Bob")

Translation: Release a previously reserved source by the source's name from user "Bob"

Responses (assuming Bob has previously reserved "Src_6" and has no other reserved sources):

(poolSta "Pool_M" :reserved [] :avail true)

(poolSta "Pool_S" :reserved [] :avail true)

(userSta "Bob" :reserved [])

**Note:* The API may respond with a list of all the pools and their reservations and availability even if the release action did not involve them.

**Note:* As shown above, (userSta "Bob" :reserved... will be followed by a list of [pool name, source] pairs currently reserved to Bob. Since Bob currently has no reserved sources, this is an empty list.

Request a list of sources reserved to one user: (userSta? <user> :user <user>)

Example: (userSta? "Bob" :user "Bob")

Translation: Request the current status of user Bob.

Response (assuming Bob has previously reserved "Src_6" and has no other reserved sources):

(userSta "Bob" :reserved [["POOL_S", "Src_6"]])

Request status of all the users and the sources reserved to them: (userSta? "*" :user <user>)

Example: (userSta? "*" :user "admin")

Translation: Request the current status of all users.

Responses:

(userSta "Bob" :reserved [["POOL_S", "Src_6"]])

(userSta "Carol" :reserved [])

(userSta "Geddy" :reserved [])

(userSta "Neal" :reserved [["POOL_S", "Src_4"], ["POOL_S", "Src_5"]])

(userSta "Alex" :reserved [])

Request list of published sources: (poolSta? "PUBUNP" :user <user>)

Example: (poolSta? "PUBUNP" :user "admin")

Translation: Published sources are available as video only resources to all users. PUBUNP is a symbolic pool name and is not managed by the usual pool configuration options. Any time a source is published or unpublished, the API will automatically receive an unsolicited update, but the API can also request the published list explicitly as shown here.

Responses:

(poolSta "PUBUNP" :published ["Src 1", "Src 7"])

**Note:* When a source is unpublished by one of the clients, any existing connections from that source will automatically be disconnected. In practice this means that multiple dstSta and kbdSta messages may follow notice that the poolSta "PUBUNP" has changed.

Configuration Access

Request a description of all the sources, destinations, keyboards, and matrix switches.

Example: (fileDef? "stations.csv" :user "admin")

Translation: Request the contents of the stations file. The program will return a double quoted, csv (comma separated values) string with information about the sources, destinations, keyboards, matrices, etc.

Response:

```
(fileDef "stations.csv" :text "
Frm Name:,Xoff:,Yoff:,W:,H:,BGround:,Color:,Border:
dstsBG,21.05,1,68.5,95,#151515,#fff,1px solid #777
macsBG,90,1,9,94.6,#000,#fff,
srcsBG,0.1,1,20.5,95,#222,#fff,1px solid #777
Src Name:,Follows:,Primary:,VIDa(R):,VIDb(R):,Bck(T):,HIDs(R):,HIDd(T):,
AUDs(R):,AUDd(T):,!FLXs(R):,!FLXd(T):,Alias:,BGround:,Color:,
X:,Y:,W:,H:,Level:,Rank:
Src A,,,A__5,,,A__5,A__5,,,,,PC<br>1,#0f8bc8,,,,24,14,,20
Src B,,,A__6,,,A__6,A__6,,,,,PC<br>2,#0f8bc8,,,,24,14,,40
. . . .
Dst Name:,Follows:,Control:,VIDa(T):,VIDb(T):,Bck(R):,HIDs(T):,HIDd(R):,
AUDs(T):,AUDd(R):,!FLXs(T):,!FLXd(R):,Alias:,BGround:,Color:,
X:,Y:,W:,H:,Level:,Rank:
Dst 1,,HID 1,A__25,A__18,A__25,,,,,(blank),,,54,68,8,7,,20
Dst 2,,HID 2,A__26,A__20,A__26,,,,,(blank),,,62.5,68,8,7,,40
. . . .
Kbd Name:,Follows:,HIDd(R):,HIDs(T):,AUDd(R):,AUDs(T):,BGround:,Rank:
HID 1,,A__30,A__30,,,kbd_white_bar.png,20
HID 2,,A__46,A__46,,,kbd_white_bar.png,40
. . . .
Mtx Name:,Model:,IP:,Port:,Status:,Rank:
A,TLX320,192.168.13.15,17567,Live,20
"
```

***Note:** The field names and meanings are described in the SMP3 manual.

Appendix K: Backing up the configuration

It is recommended that the /opt/tl/setup directory be backed up (copied) both upon receipt of the unit (factory default) and occasionally as changes are made. You may also wish to include the date in the filename.

To do so:

- Log into the SMP unit and elevate to root.
- Navigate to the /opt/tl directory.
- Issue a copy command, for example: “cp -r setup setup-default”. The “-r” is required to include the subdirectories. (For example, the “macros” directory)

Here is an example of a test unit:

```
[root@smp-mod user]# cd /opt/tl
[root@smp-mod tl]# ll
total 48
drwxr-xr-x 6 root root 4096 Oct 19 14:17 adm
drwxr-xr-x 3 root root 4096 May 1 2023 cache
drwxr-xr-x 5 root root 4096 May 1 2023 dash
drwxr-xr-x 2 root root 4096 Feb 29 10:37 licenses
drwxr-xr-x 6 root root 4096 Mar 18 14:42 pkg
drwxr-xr-x 6 root root 4096 Mar 26 07:51 setup
drwxr-xr-x 6 root root 4096 Mar 28 09:51 setup-2024-03-28
drwxr-xr-x 5 root root 4096 Feb 28 15:30 setup_default
drwxr-xr-x 6 root root 4096 Mar 14 14:41 setup-mfg-tp-tester
drwxr-xr-x 5 root root 4096 Mar 25 15:18 setup-training
drwxr-xr-x 7 root root 4096 Mar 18 14:42 smp2
drwxr-xr-x 2 root root 4096 May 1 2023 tools
```

There are five setup directories on this test machine. However, only /opt/tl/setup will be used by the system.

To change to a different configuration:

- “rm -rf setup” – This deletes the currently used configuration.
- “cp -r setup-2024-03-28 setup” – copies a backed up configuration to be the ‘active’ one.
- “systemctl restart tl-smp2” – Restarts the SMP3 service to read the new configuration.

You may also choose to make a copy of the backup directory offline, such as on a laptop, etc. The utility WinSCP is convenient for this purpose. However, when using WinSCP you will first have to move the backup to/from the SMP /tmp directory for permissions purposes.



Note: Flash drive usage is disabled due to security reasons.

Appendix L: Upgrading from prior versions

Saving the Factory Default configuration:

It is recommended to first make a copy of the factory default setup directory upon receipt of the new SSD with the new software. See prior Appendix K.

Saving the license file:

You navigate to the /opt/tl/licenses directory and copy the license file from the SMP to your laptop. This file will need to be copied onto the new SMP SSD card.

```
[root@smp-mod /]# cd /opt/tl/licenses/  
[root@smp-mod licenses]# ll  
total 4  
-rw-r--r-- 1 root root 68 Feb 29 10:37 SMP2_160_007469.lic
```

Upgrading from SMP3 without ADM:

You may simply replace the /opt/tl/setup directory with your backup copy. However, you will not be able to login to ADM after doing so. To resolve this issue, copy the **usersAdm.csv** file from the default directory created above in Appendix K into the now active /opt/tl/setup directory.

Upgrading from SMP2

- 1) Depending on the version of SMP2 used prior, there will be columns missing that exist in SMP3. While this will not inhibit the functionality, these columns are needed for some SMP3 features you may wish to use.
- 2) See also usersAdm.csv file note above.
- 3) The Drag & Drop icon geometry is defined differently between SMP2 and SMP3 and the icons will not display properly. If necessary, there is a “pixel2percent” utility available through Tech Support. After running this utility some final adjustments will be necessary.
- 4) TAGS definitions will also need to be created.

In many cases it will be more convenient to save your SMP3 factory default stations.csv file to a PC and edit it using Excel. Copy and paste configuration data from the SMP2 stations.csv file to the new one.



[Note:](#) It is recommended to contact Tech Support prior to upgrading from SMP2 to SMP3.

NOTES:
